

MATEMATIKAI KOMPETENCIATERÜLET „A”

Matematika

1. évfolyam

SZÁMÍRÁS

A kiadvány KHF/3997-14/2008. engedélyszámon 2008.08.18. időponttól
tankönyvi engedélyt kapott
Educatio Kht. Kompetenciafejlesztő oktatási program kerettanterv

A kiadvány a Nemzeti Fejlesztési terv Humánerőforrás-fejlesztési Operatív Program 3.1.1. központi program (Pedagógusok és oktatási szakértők felkészítése a kompetencia alapú képzés és oktatás feladataira) keretében készült, a sulINova oktatási programcsomag részeként létrejött tanulói információhordozó. A kiadvány sikeres használatához szükséges a teljes oktatási programcsomag ismerete és használata. A teljes programcsomag elérhető: www.educatio.hu címen.

Matematika szakmai vezető: Olasz Tamásné

Szakmai tanácsadó: C. Neményi Eszter

Lektor: Palotásné Vig Marianna

Grafika: Márkus Regina

Felelős szerkesztő: Teszár Edit

H-AMAT0105

©

Szerzők:

Bóta Mária, Kólkúti Ágnes, Márkus Regina

Educatio Kht. 2008.

Tömeg: 420 gramm

Terjedelem: 9,53 (A/5 ív)

A tankönyvvé nyilvánítási eljárásban közreműködő szakértők:
Tantárgypedagógiai szakértő: Bódi Edit
Tudományos-szakmai szakértő: Tóth Szilvia Angéla
Technológiai szakértő: Karácsony Orsolya

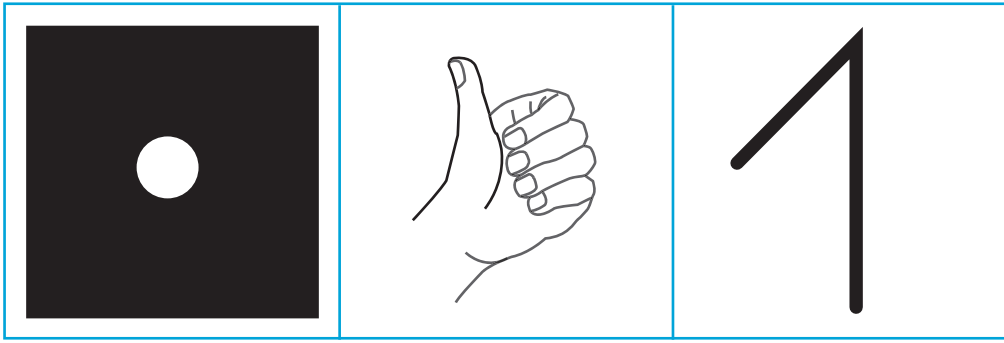

Színezd ki a rajzokat! Rajzolj valamiből egyet az üres helyekre!

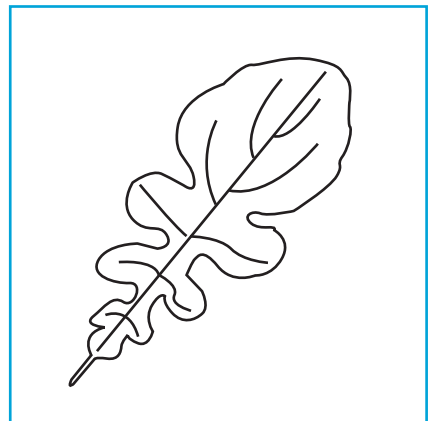
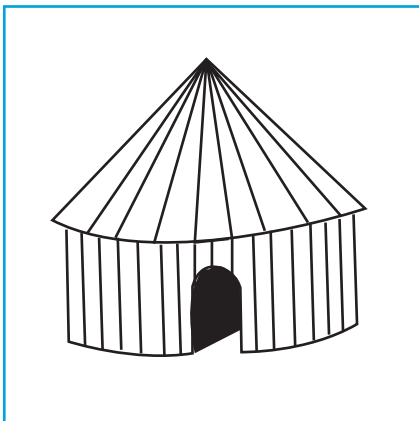
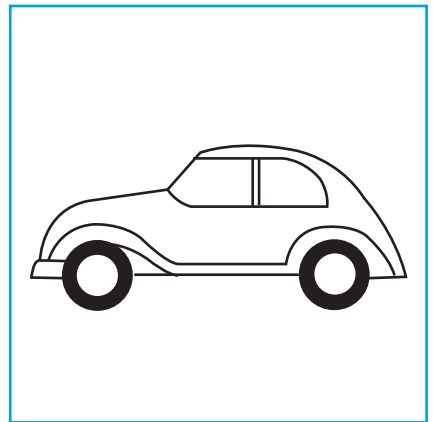
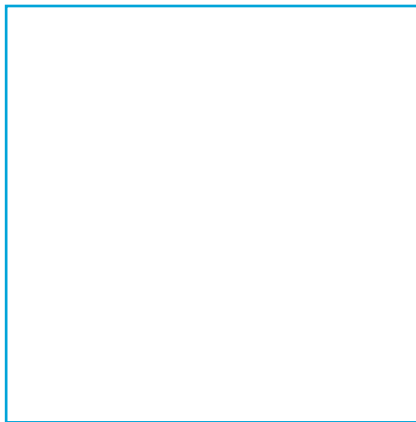
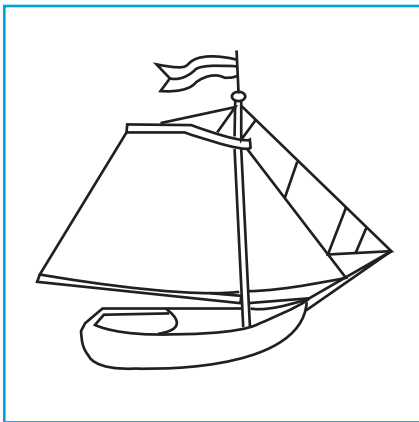
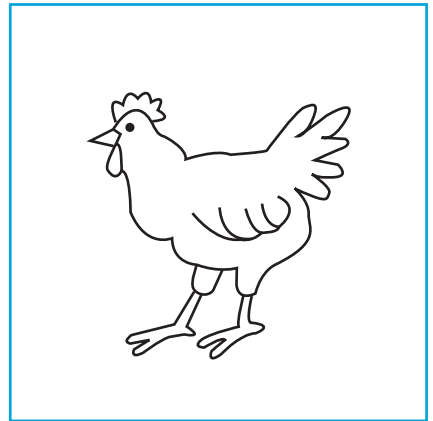
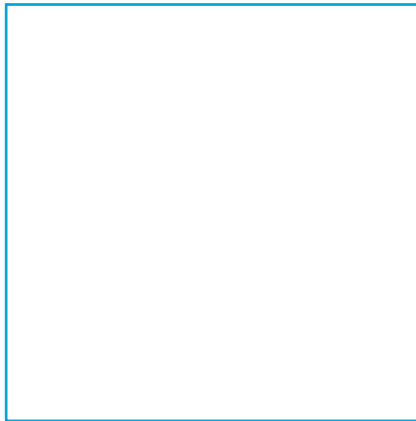
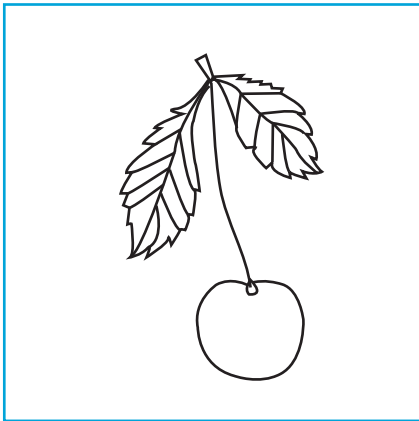

Vázold az egyes számot!
(Próbálj a vonalon belül maradni!)

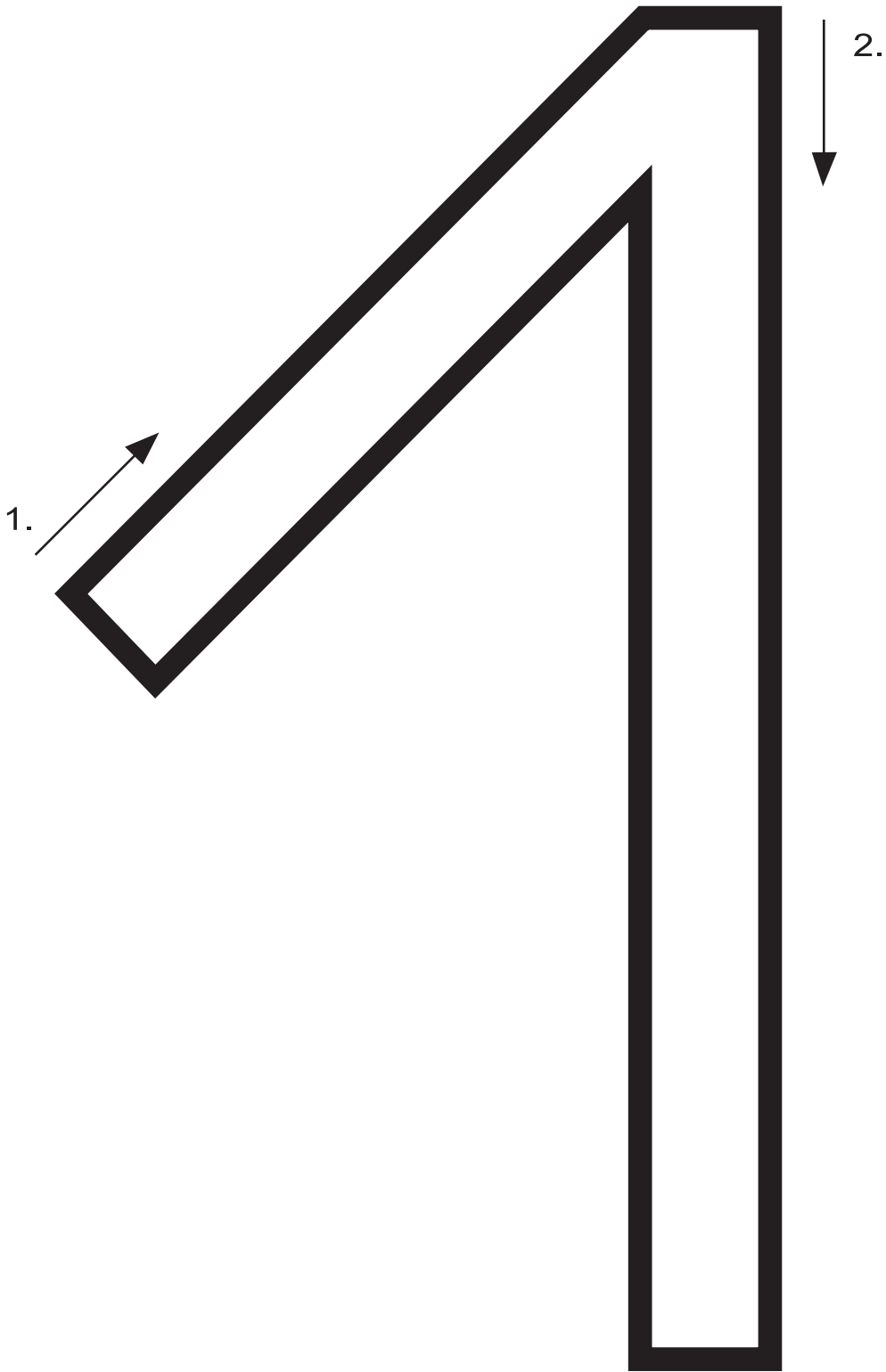

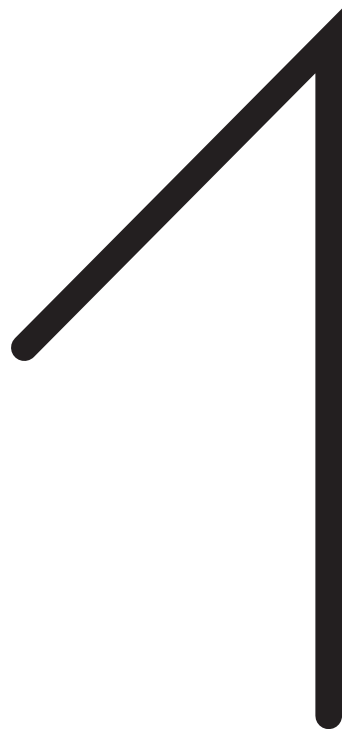
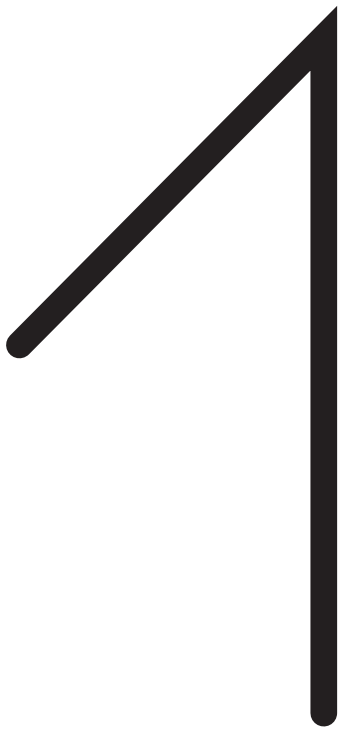
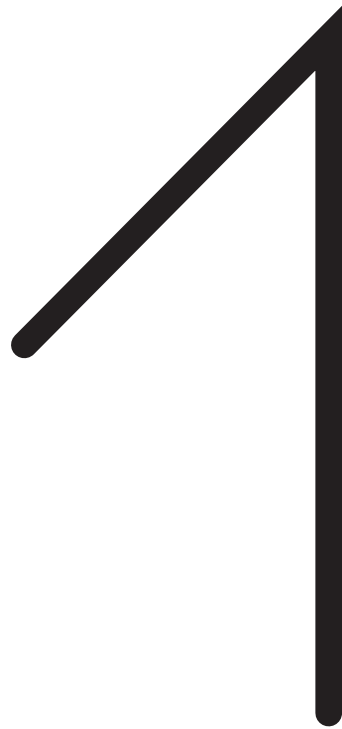
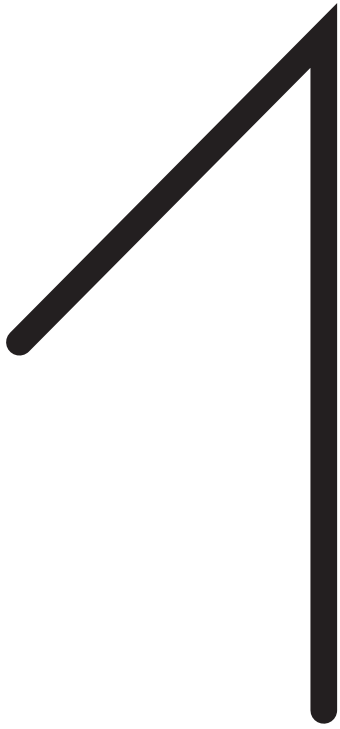

AZ EGYES SZÁM VÁZOLÁSA

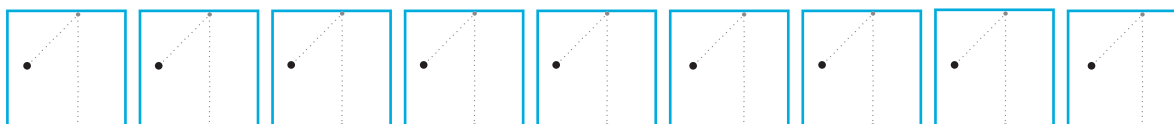
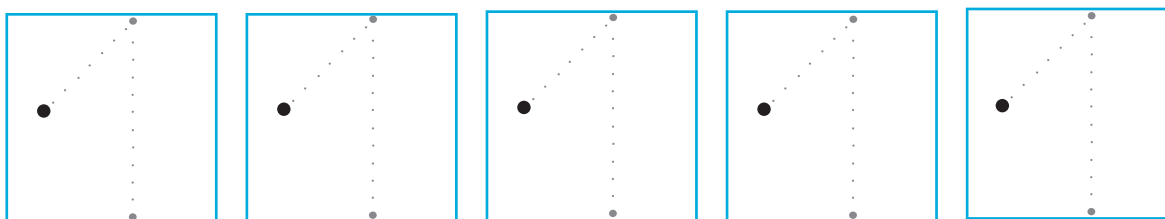
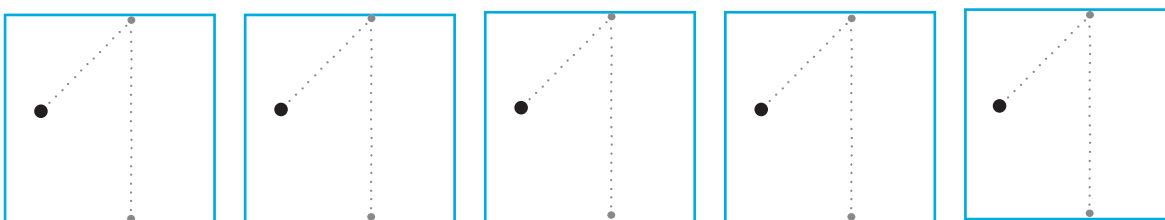
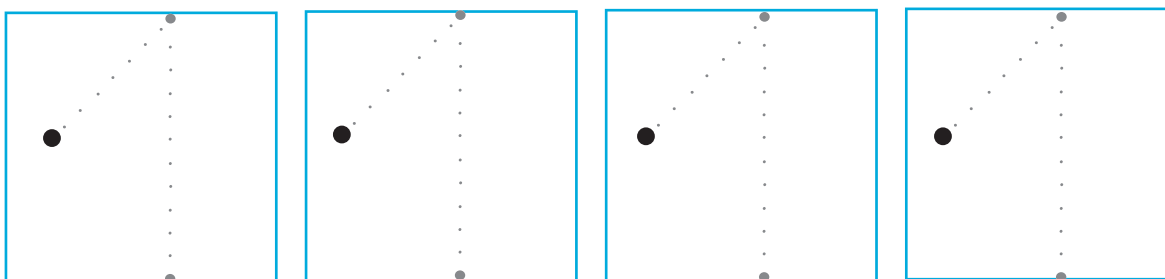
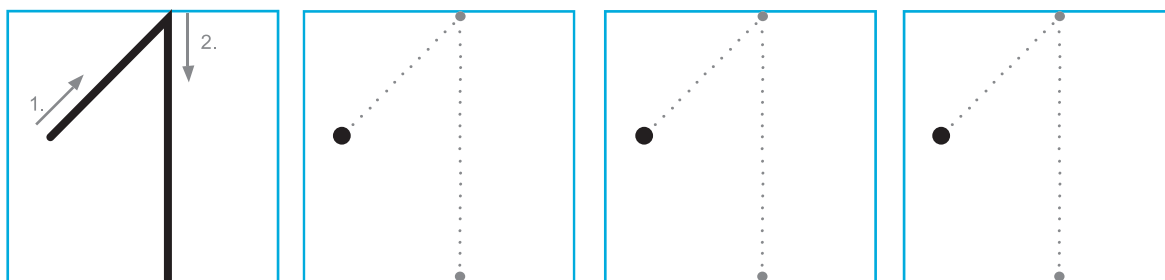



Folytasd! Indulj a kezdőponttól! Írd át többször a számokat!

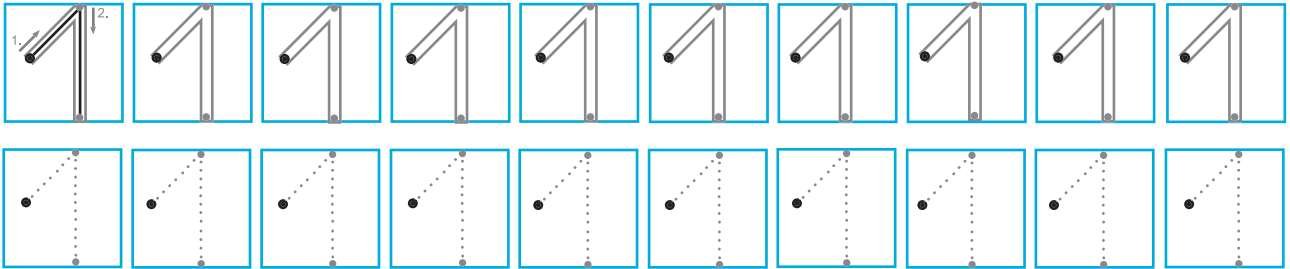

Figyelj a kezdőpontra!

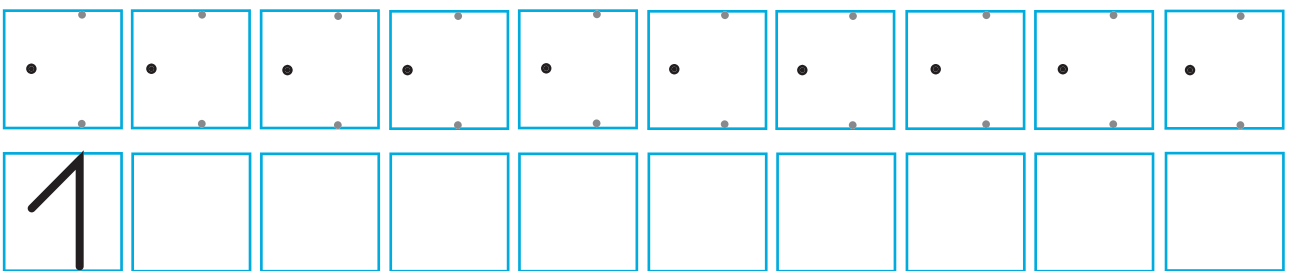

Folytasd!

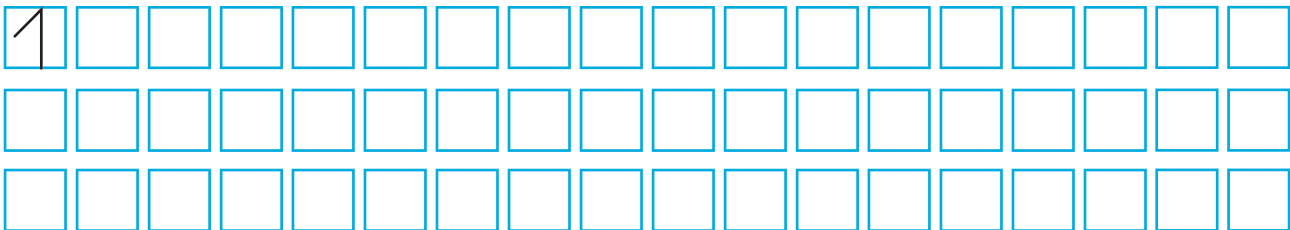

Írd át a helyes számjelet!

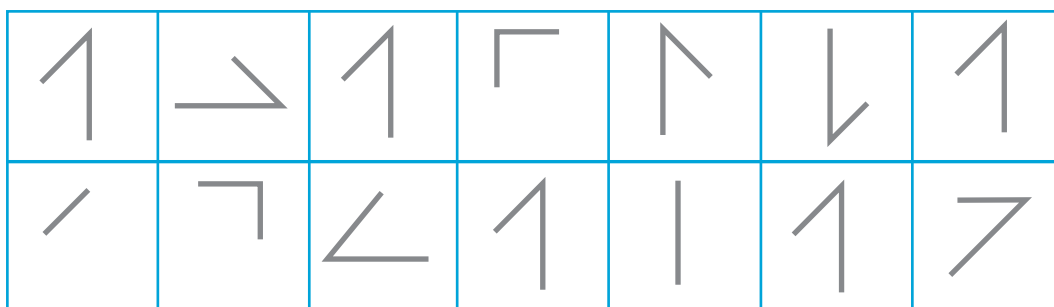

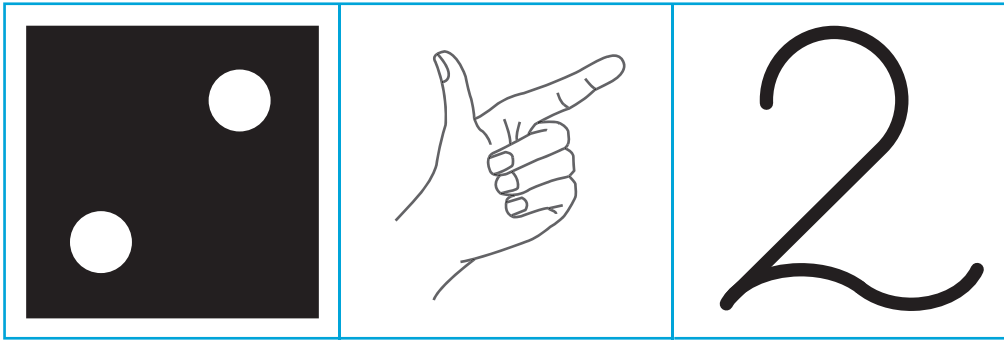

Színezd ki a rajzokat! Rajzolj valamiből kettőt az üres helyekre!

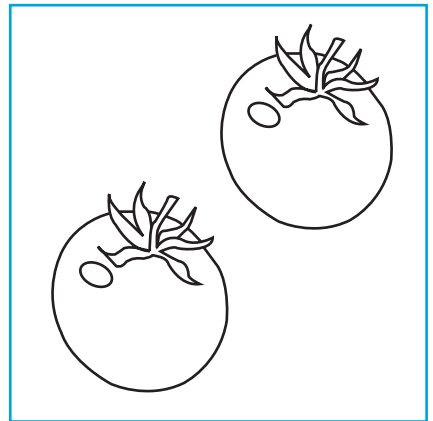
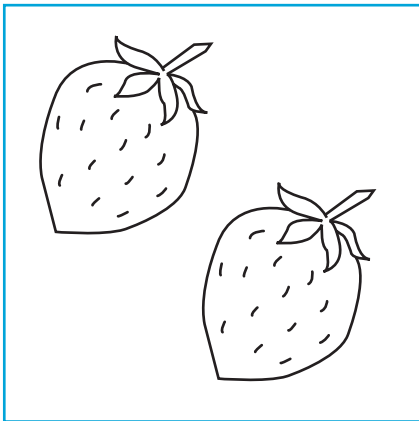
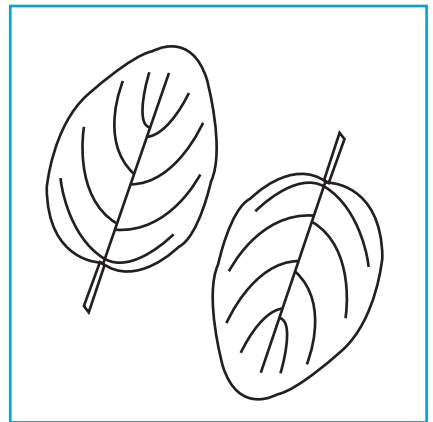
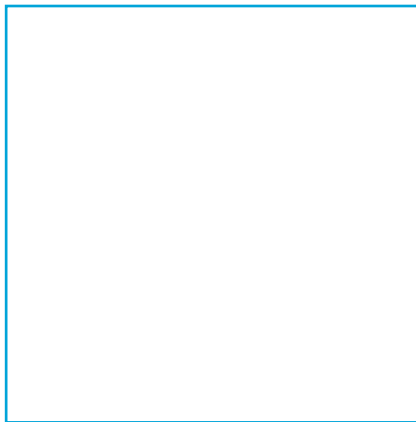
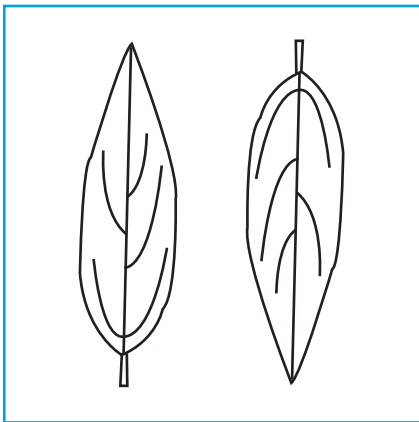
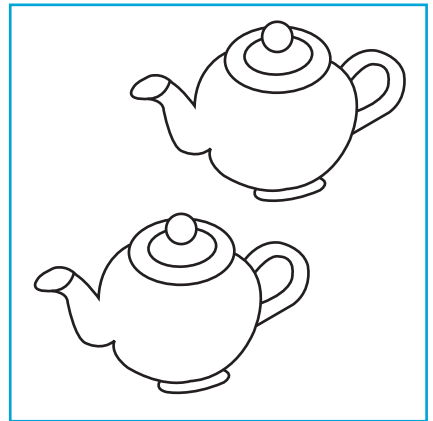
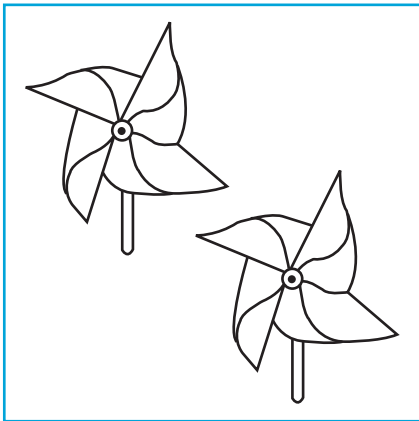

HOROGVONAL VÁZOLÁSA

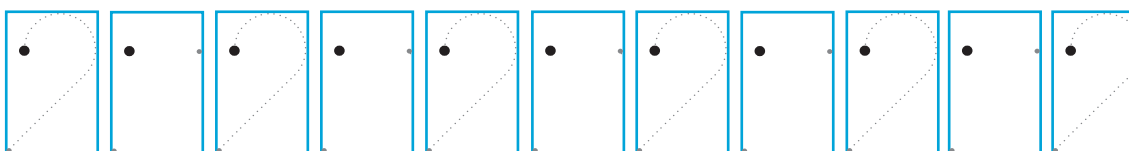
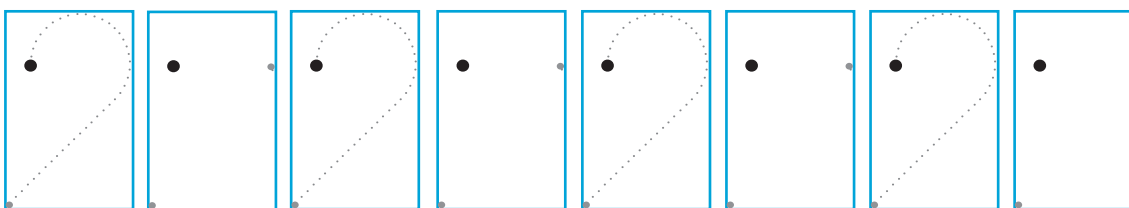
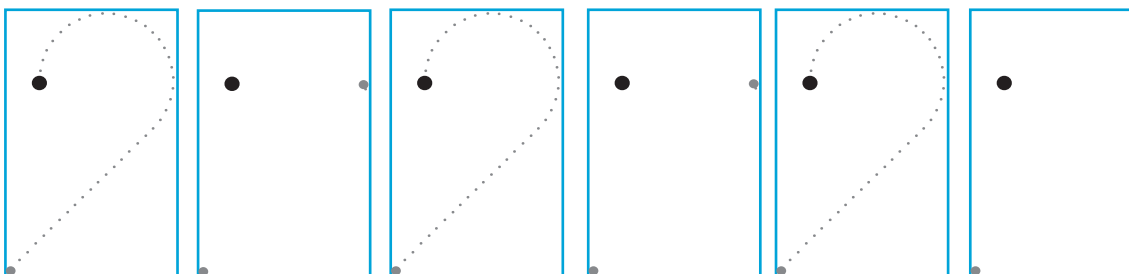
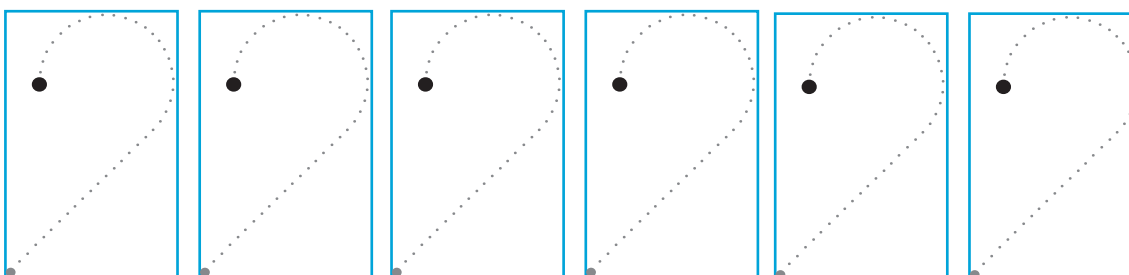
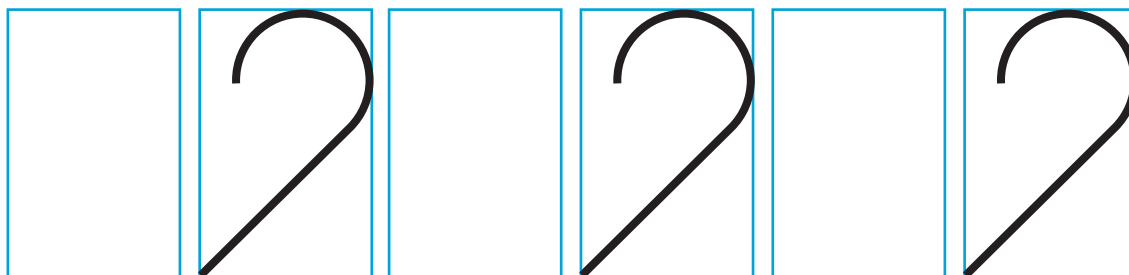
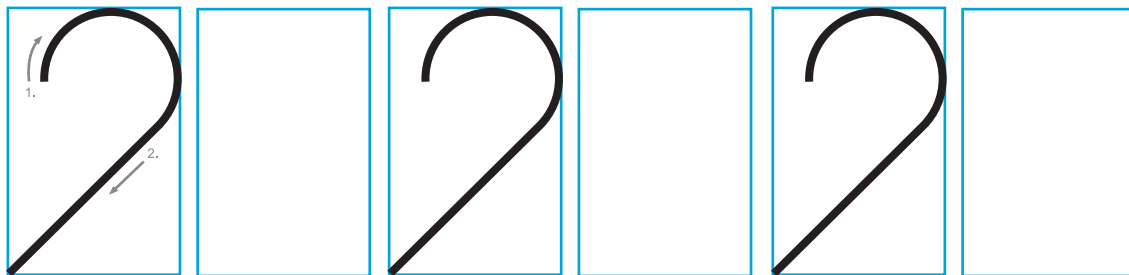

HULLÁMVONAL VÁZOLÁSA

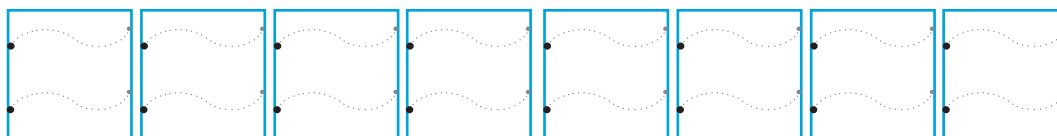
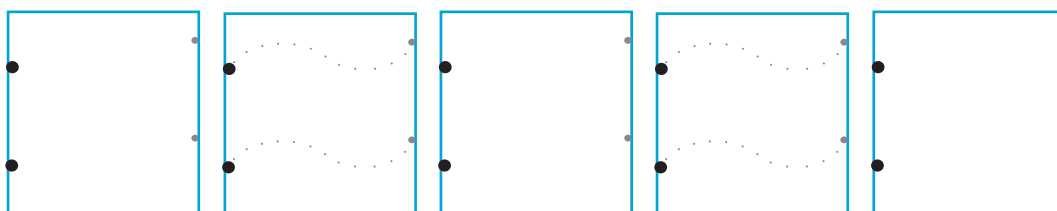
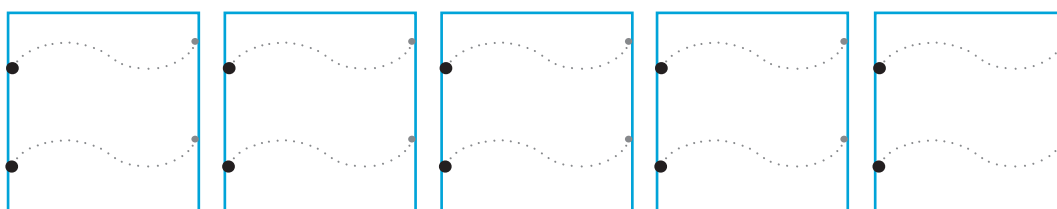
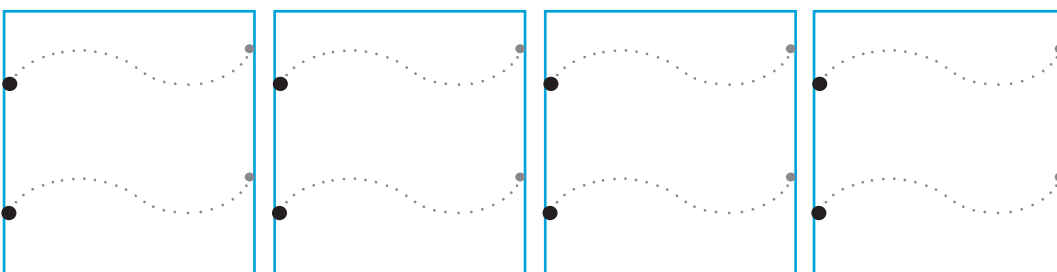
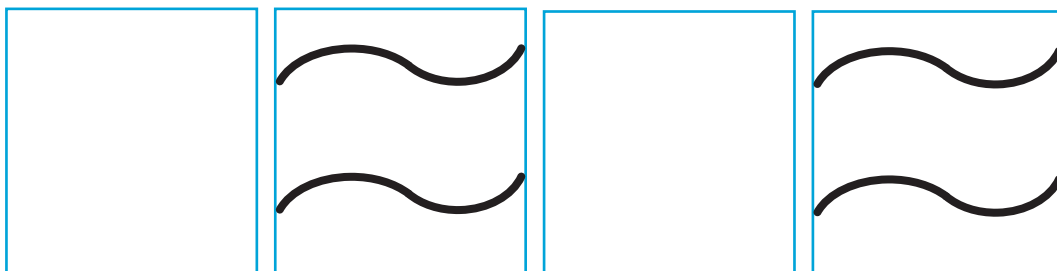
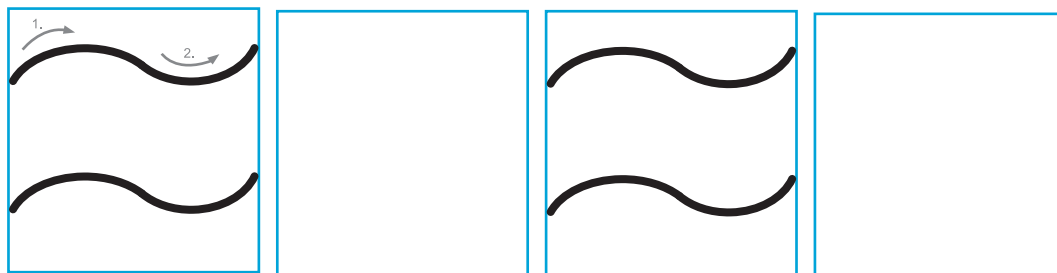

Vázold a kettes számot!
(Próbáld a vonalon belül maradni!)



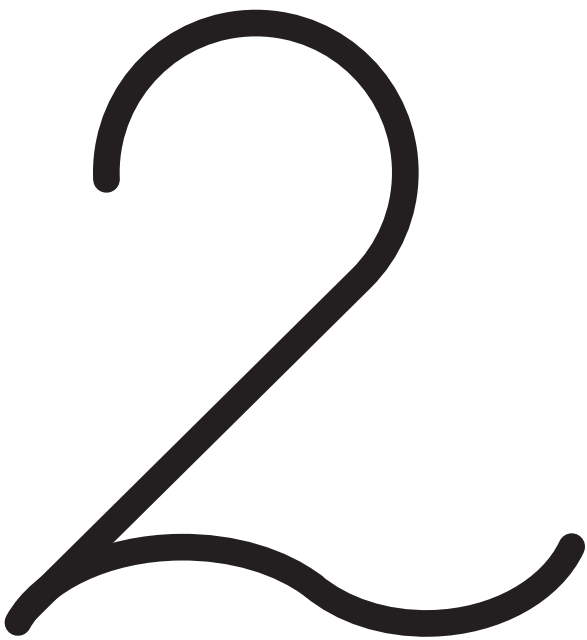
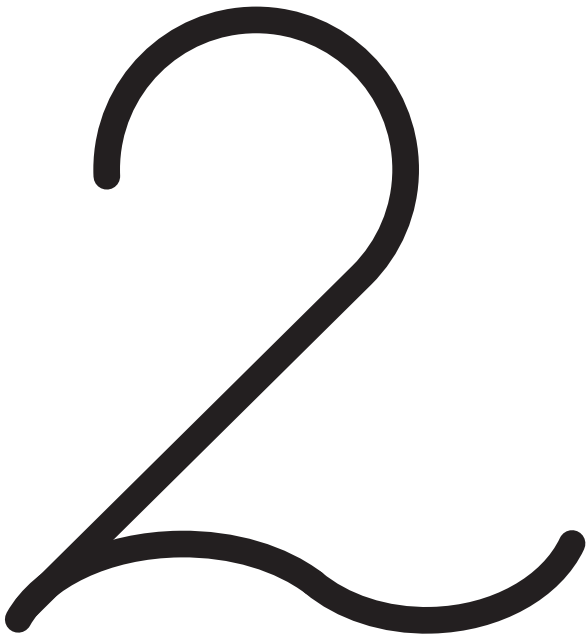

A KETTES SZÁM VÁZOLÁSA

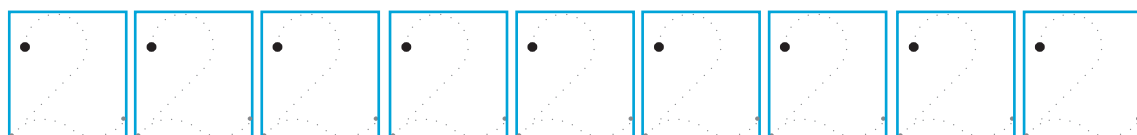
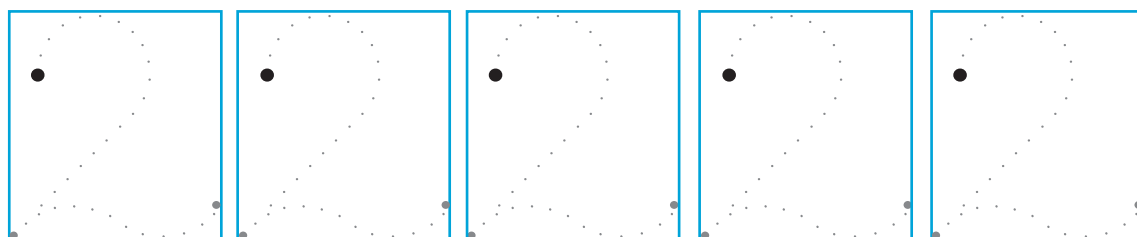
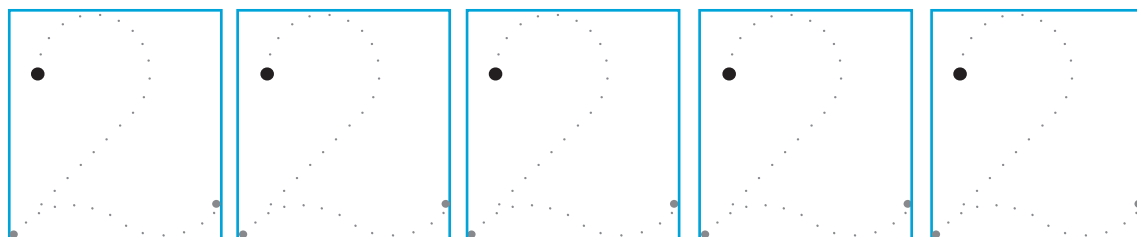
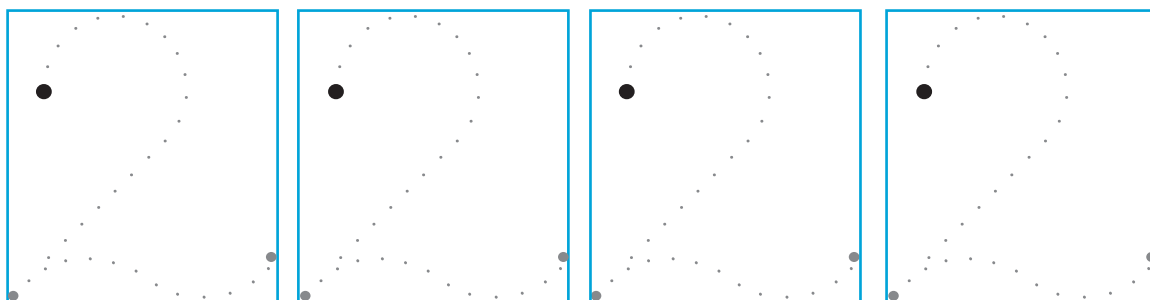
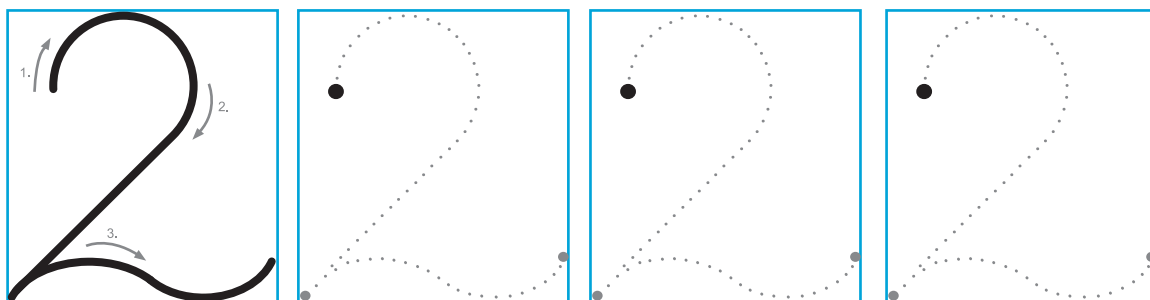

Keresd meg amiből 1 vagy 2 van és írd alá a számjelét!

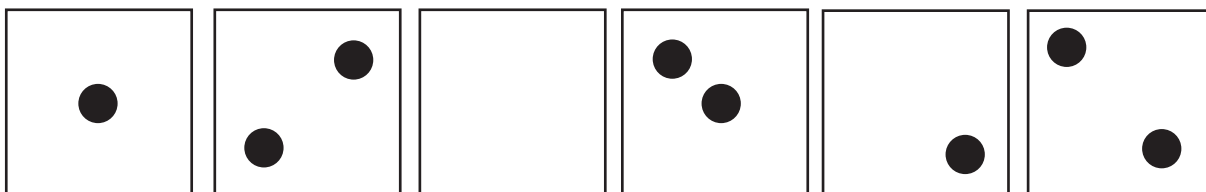
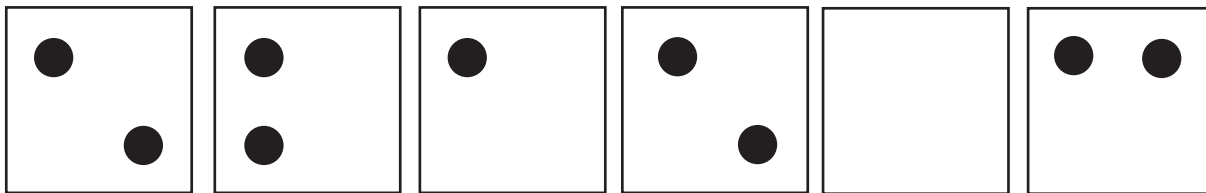

Rajzolj annyit, amennyit a szám mutat!

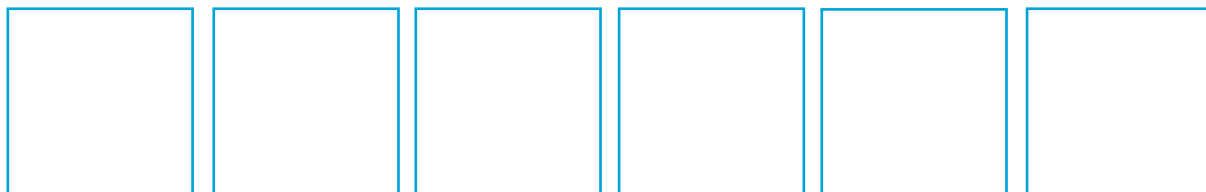

Írd az üres négyzetekbe, hogy mennyit látsz a képen!

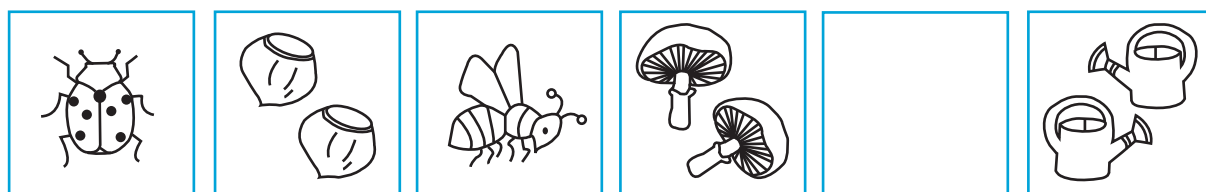



Folytasd! Indulj a kezdőponttól! Írd át többször a számokat!

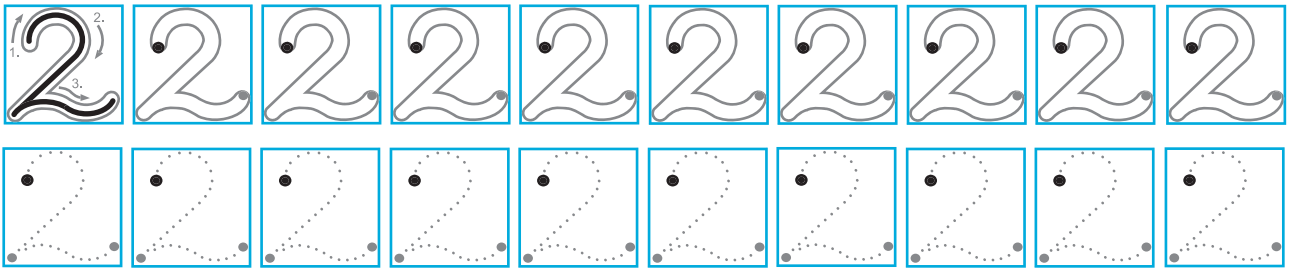

Figyelj a kezdőpontra!

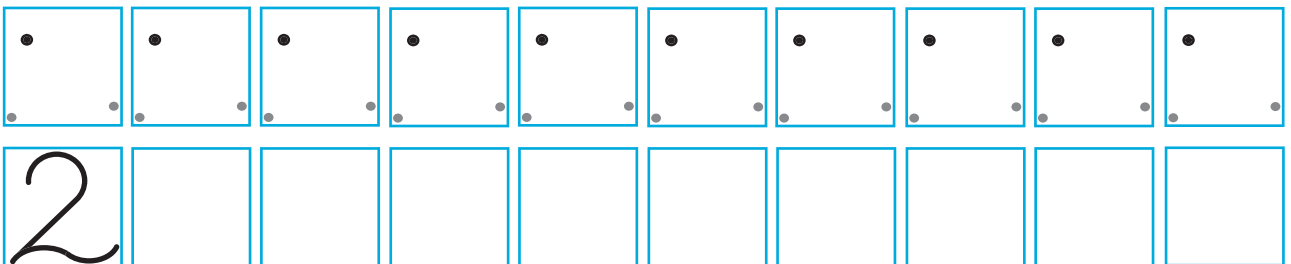

Folytasd!

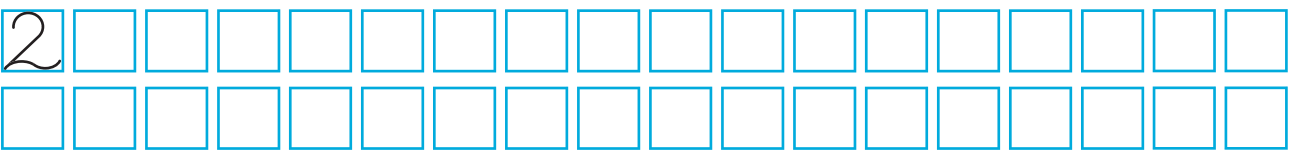

Írd át a helyes számjelet!

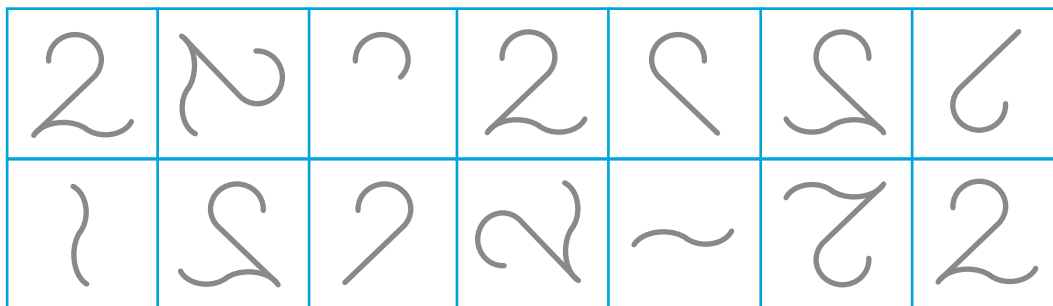

Karikázd be kettesével!

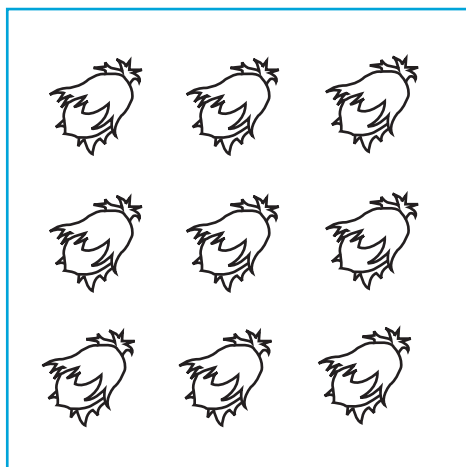

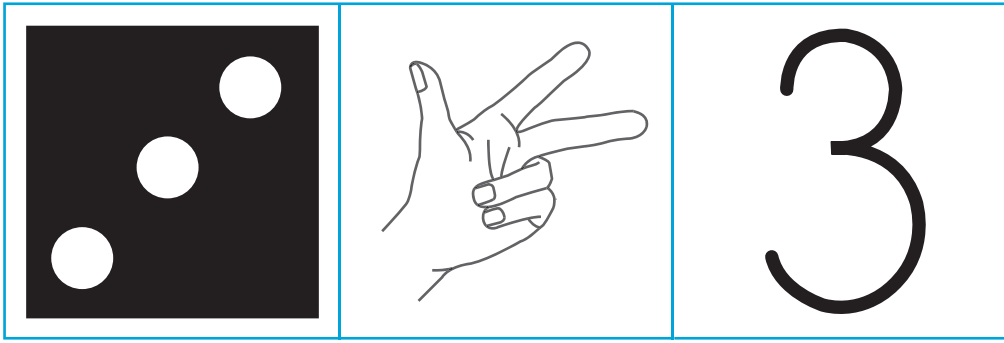

Színezd ki a rajzokat! Rajzolj valamiből hármat az üres helyekre!

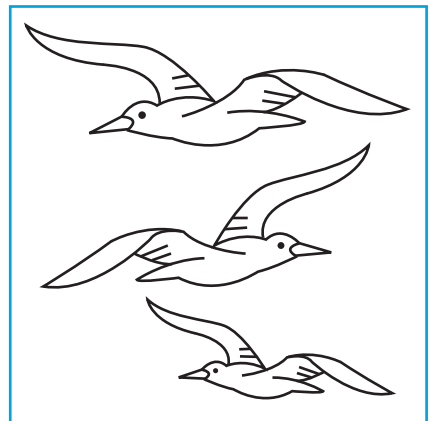
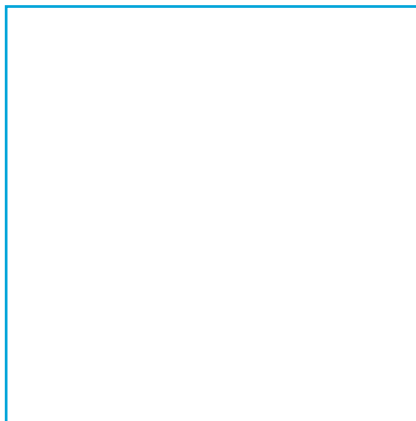
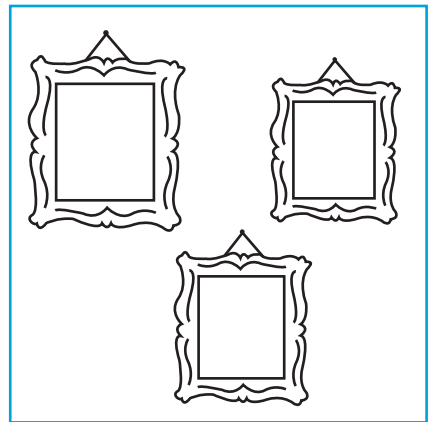
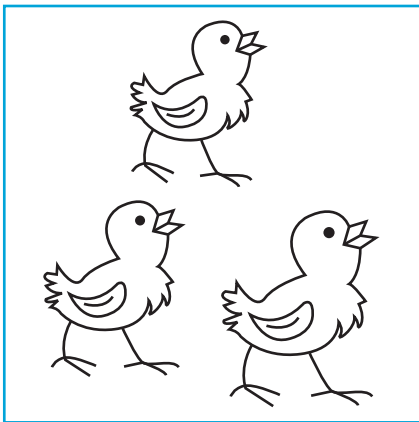
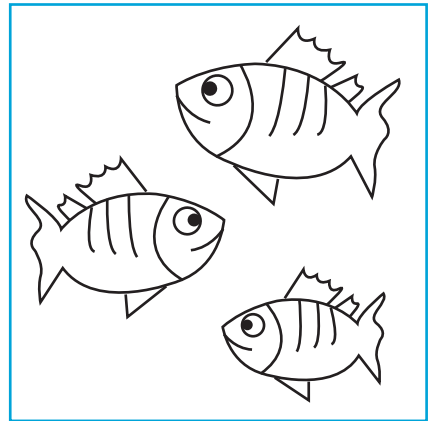
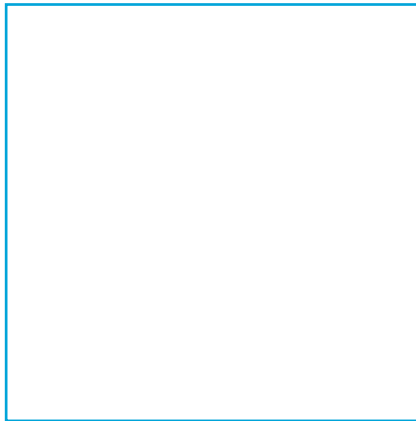
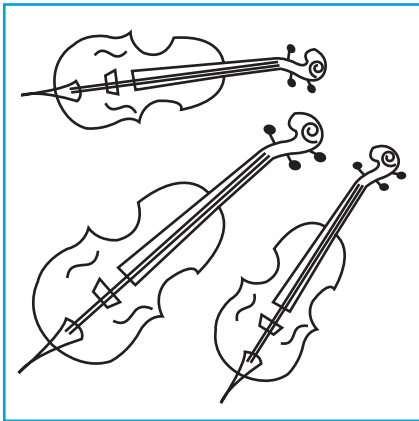

Vázold a hármas számot!
(Próbáld a vonalon belül maradni!)

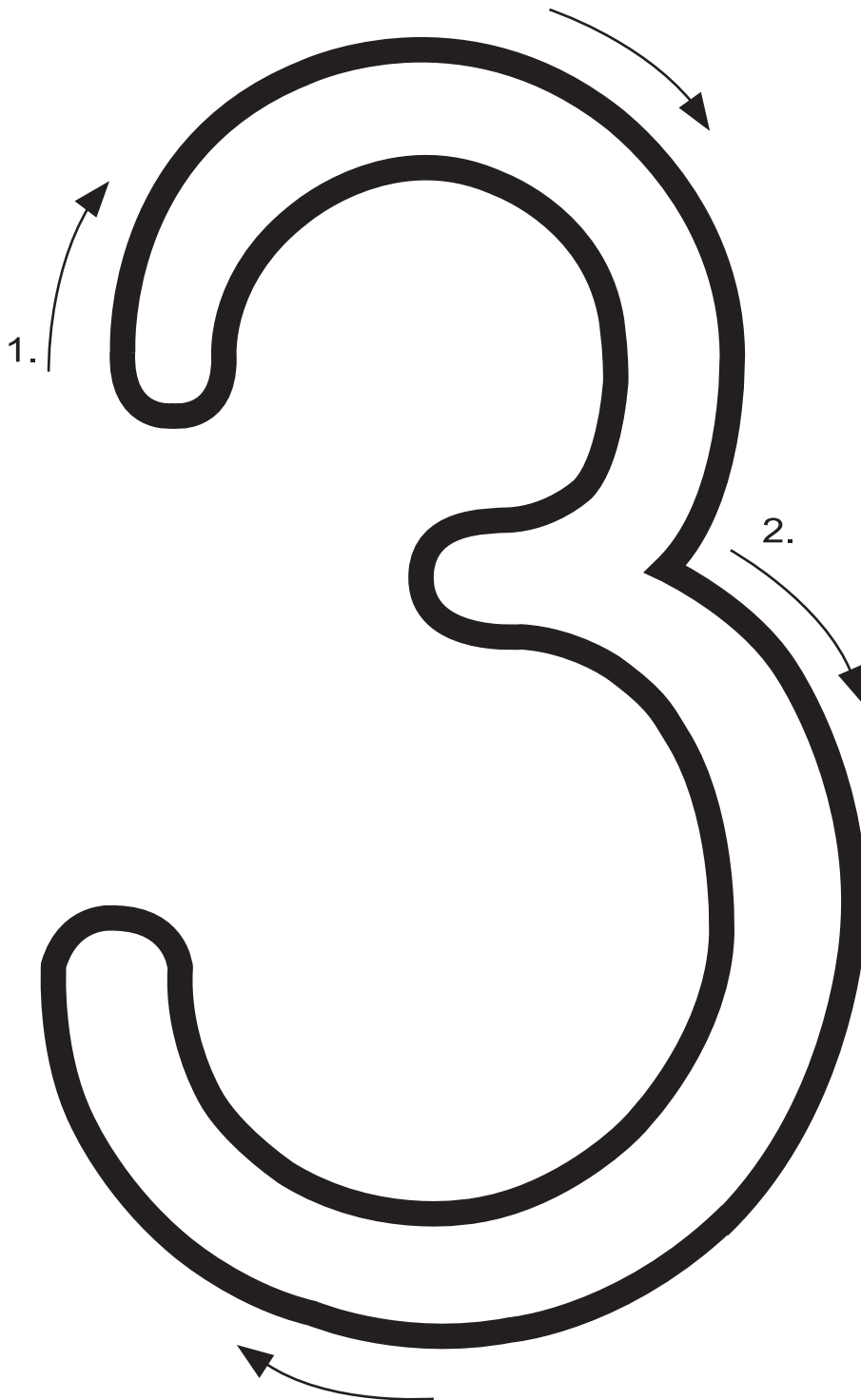

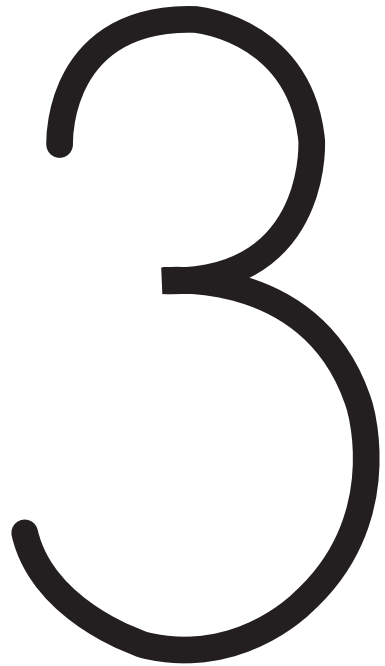
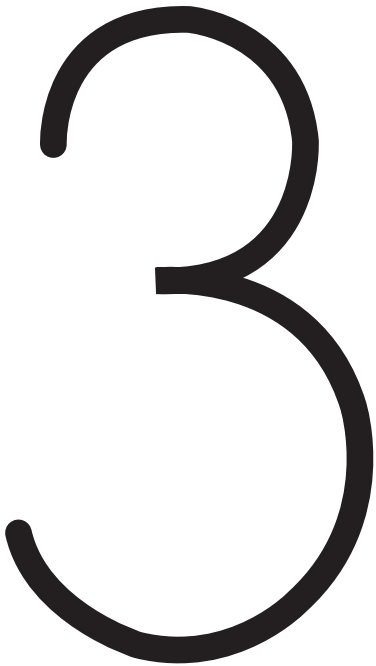
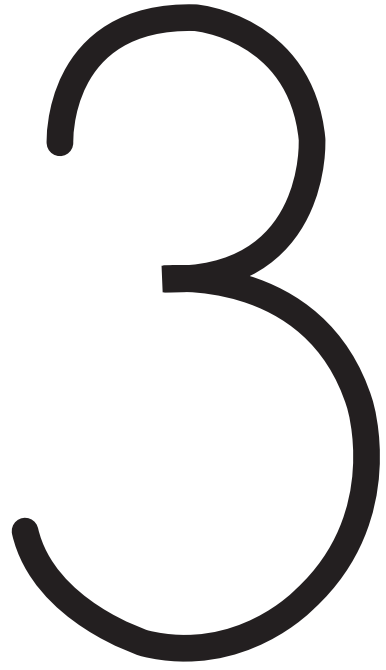
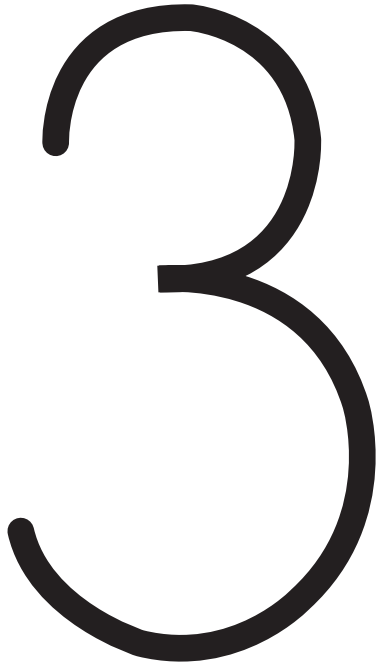

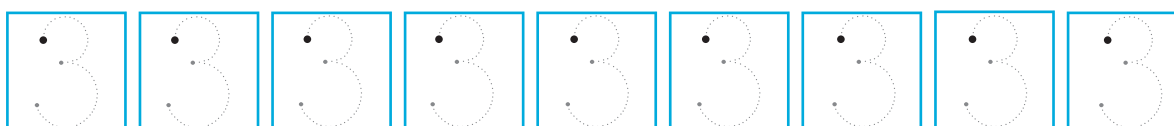
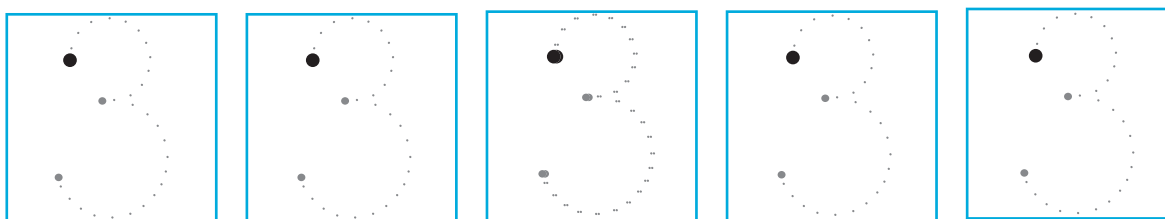
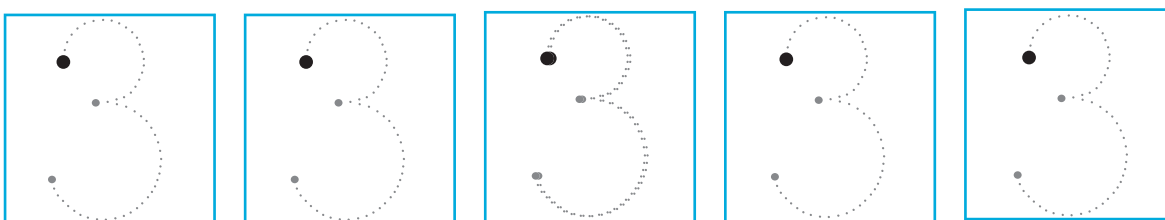
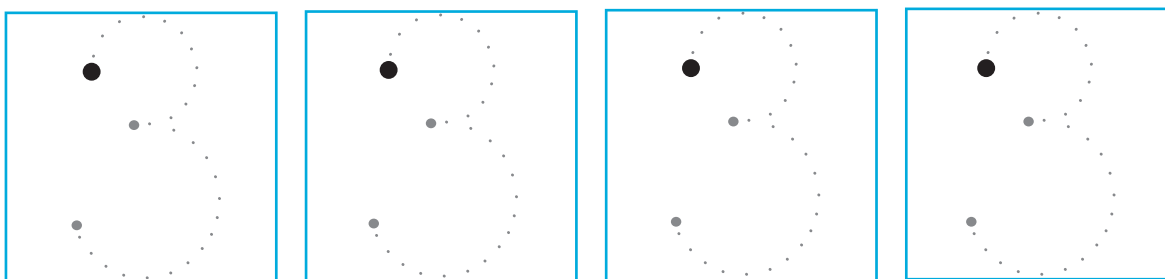
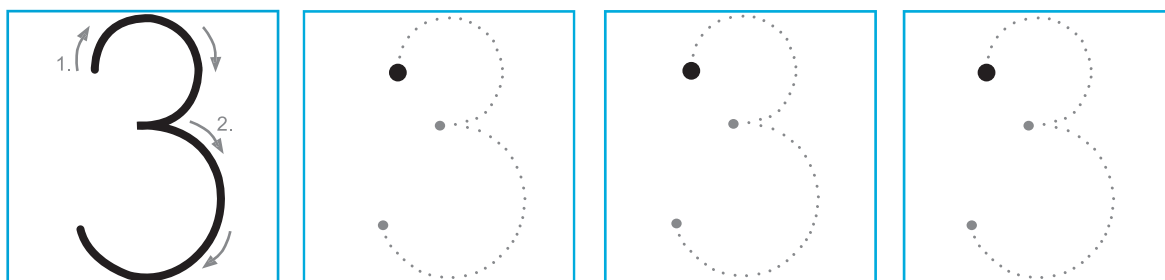

A HÁRMAS SZÁM VÁZOLÁSA

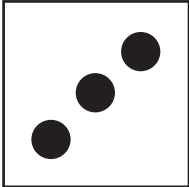
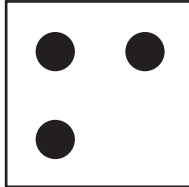

Keresd meg amiből 3 van és írd alá a számjelét!

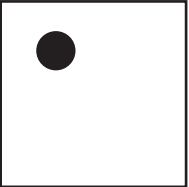
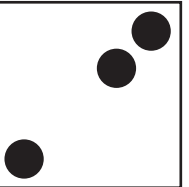
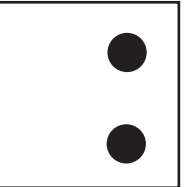
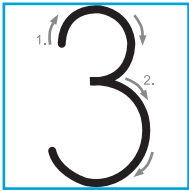

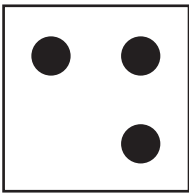
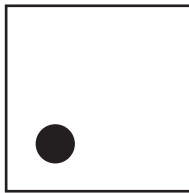
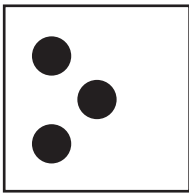
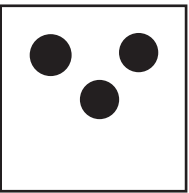
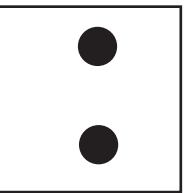
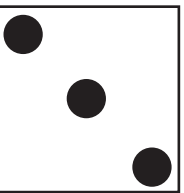

					
					

Rajzolj annyit, amennyit a szám mutat!

2	1	3	2	3	1

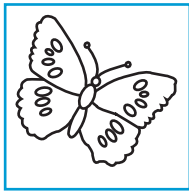
Írd az üres négyzetekbe, hogy mennyit látsz a képen!

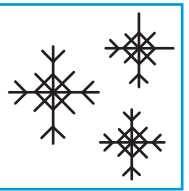

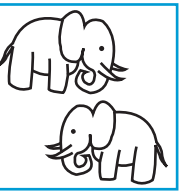

Folytasd! Indulj a kezdőponttól! Írd át többször a számokat!

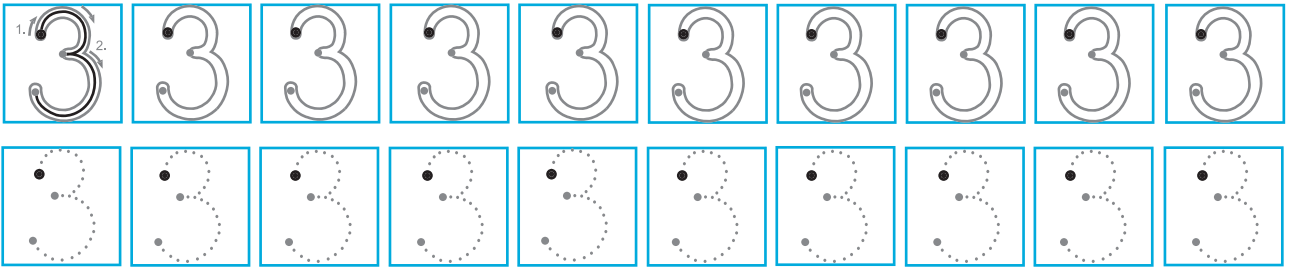

Figyelj a kezdőpontra!

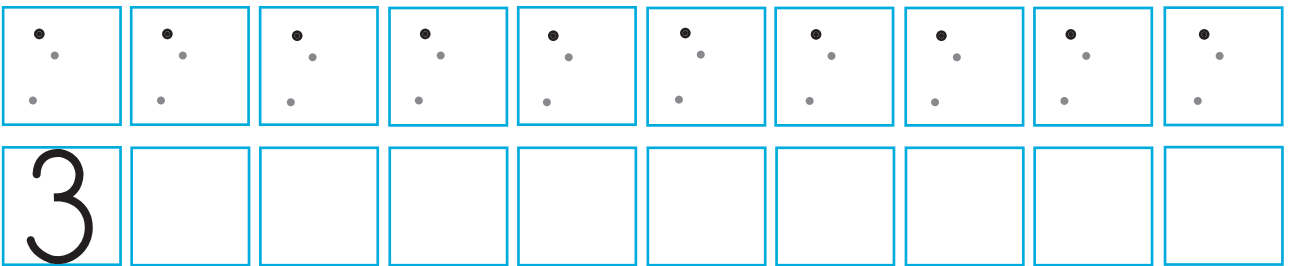

Folytasd!

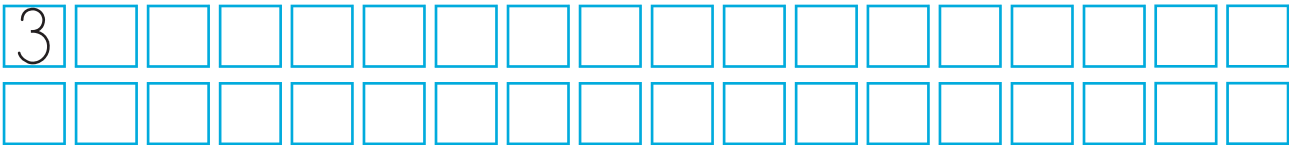

Írd át a helyes számjelet!

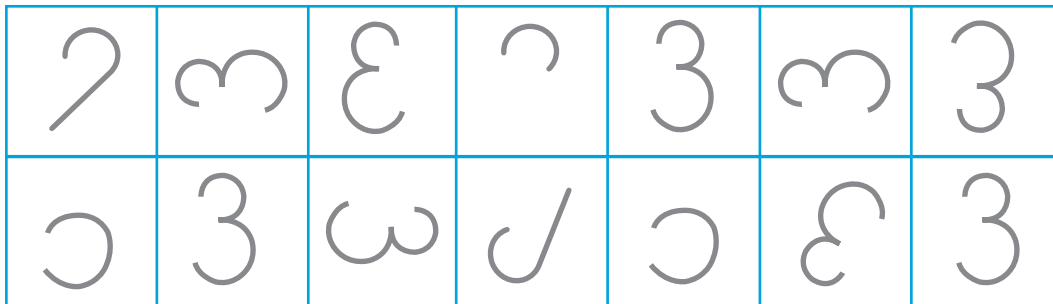

Karikázd be hármásával!

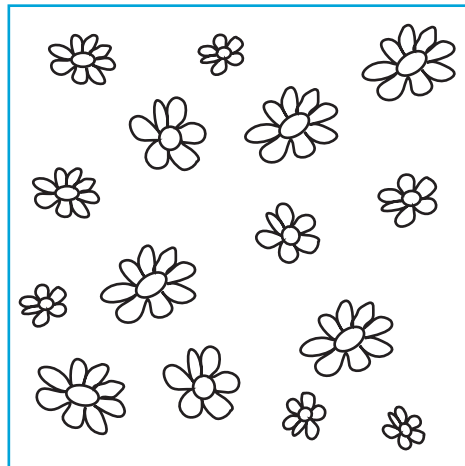
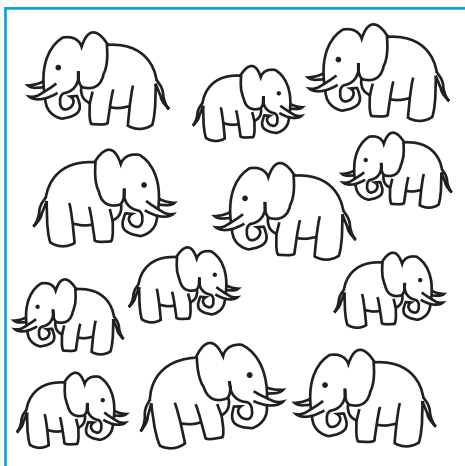

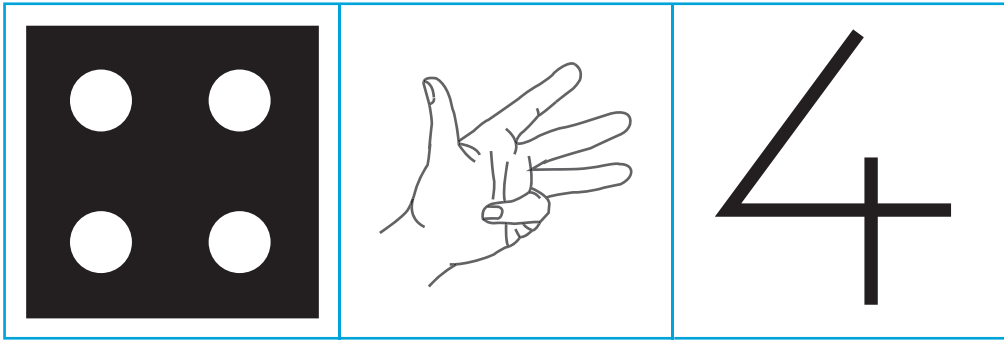

Színezd ki a rajzokat! Rajzolj valamiből négyet az üres helyekre!

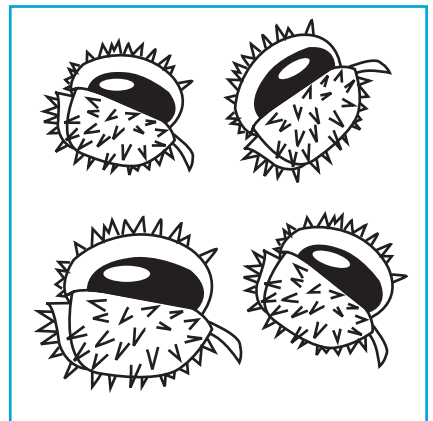
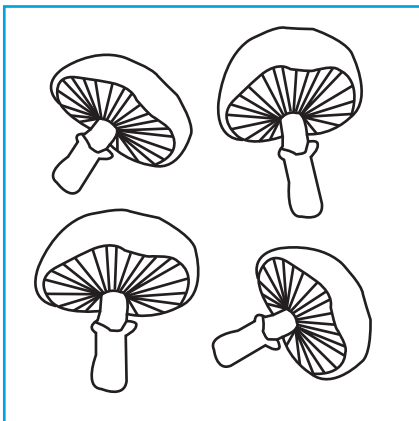
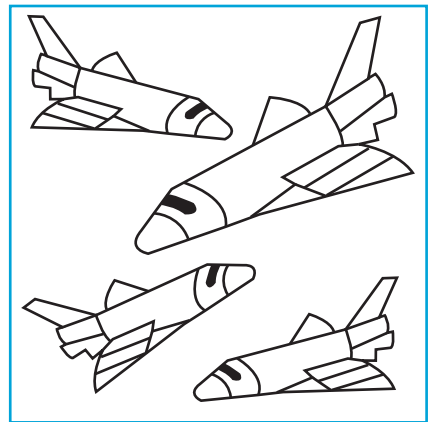
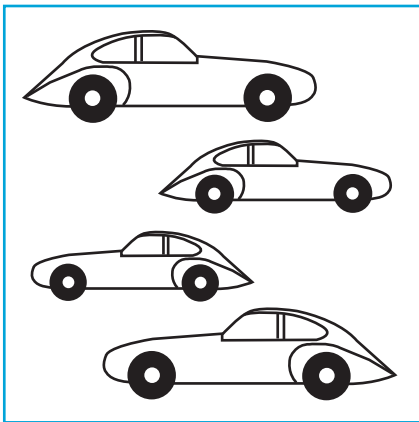
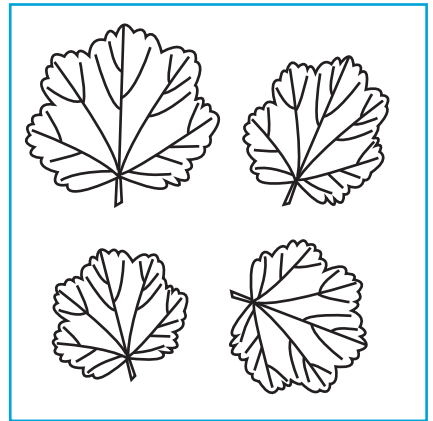
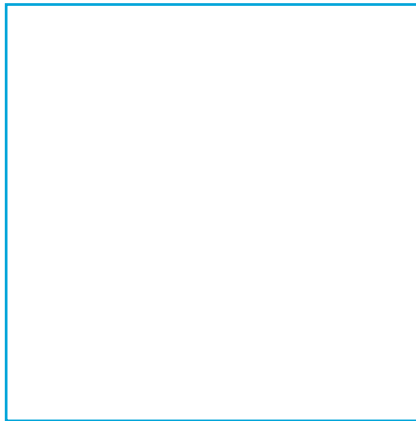
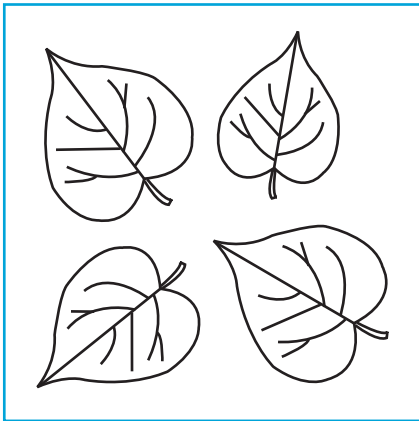

Vázold a négyes számot!
(Próbálj a vonalon belül maradni!)

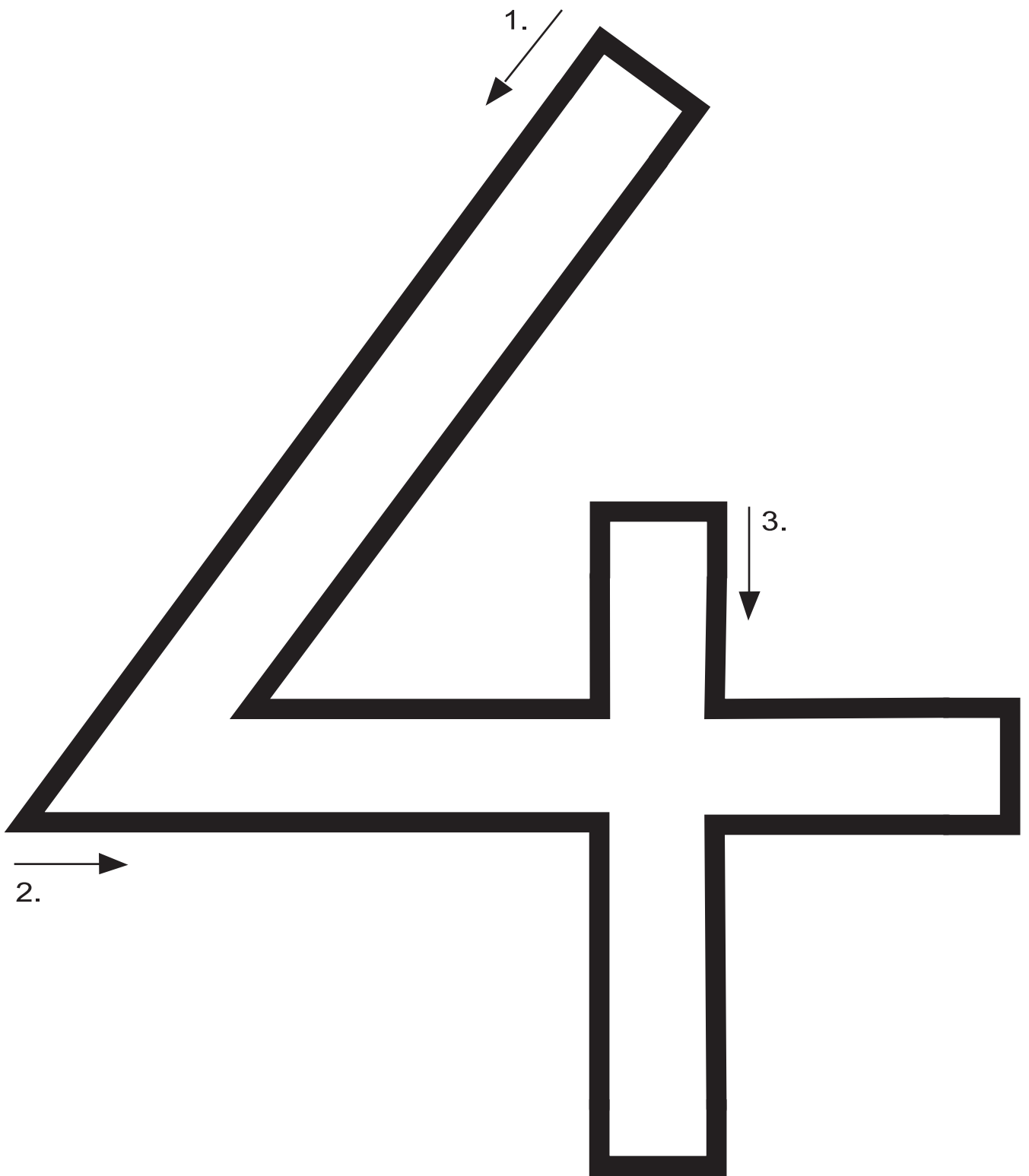

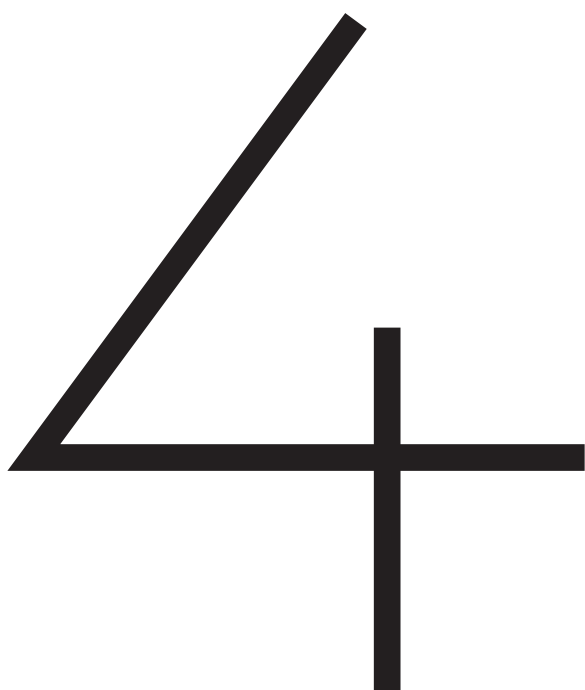
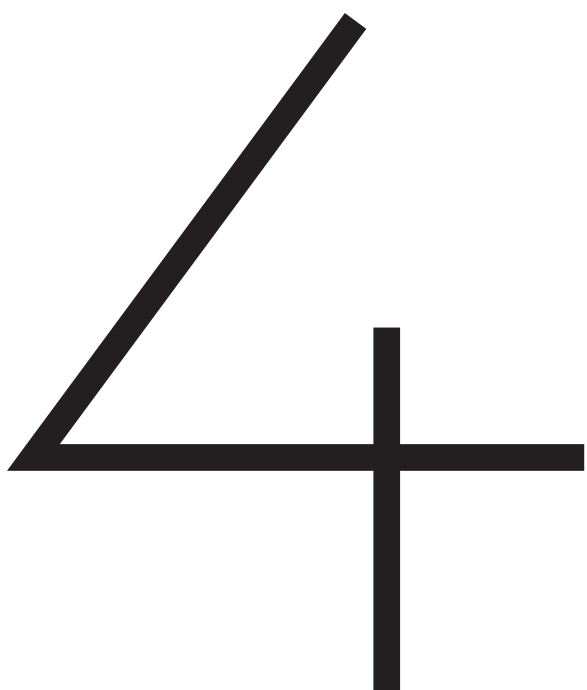
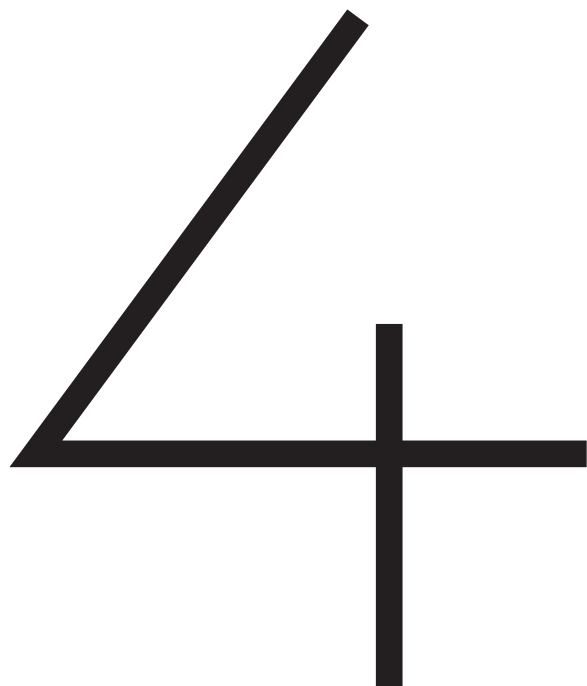
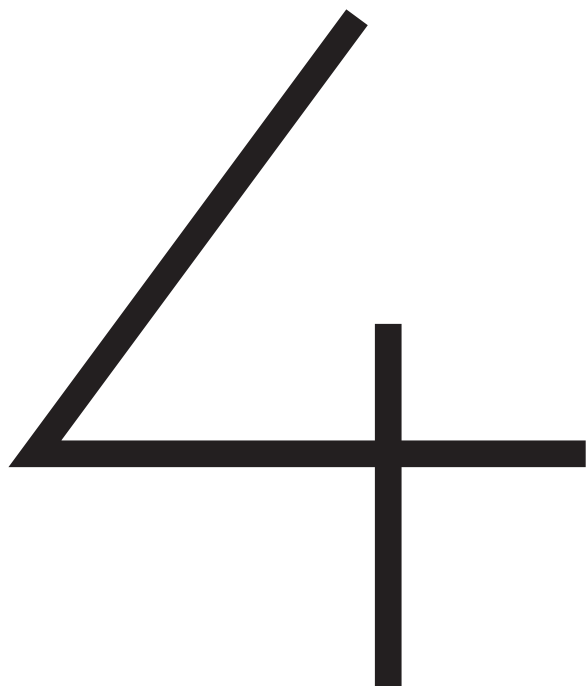

A NÉGYES SZÁM VÁZOLÁSA

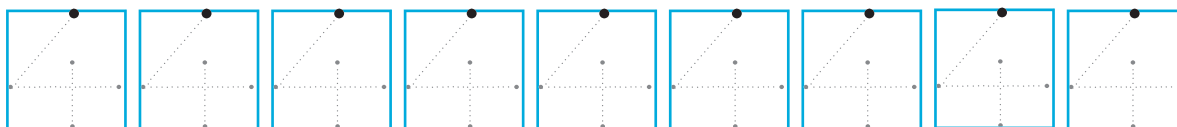
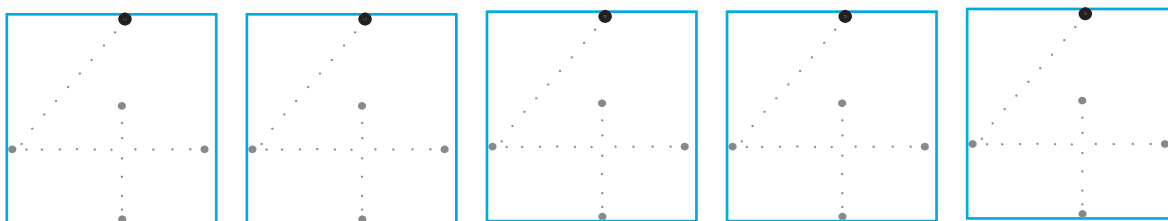
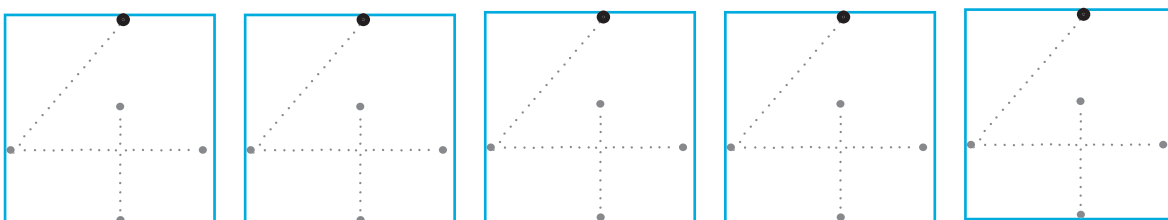
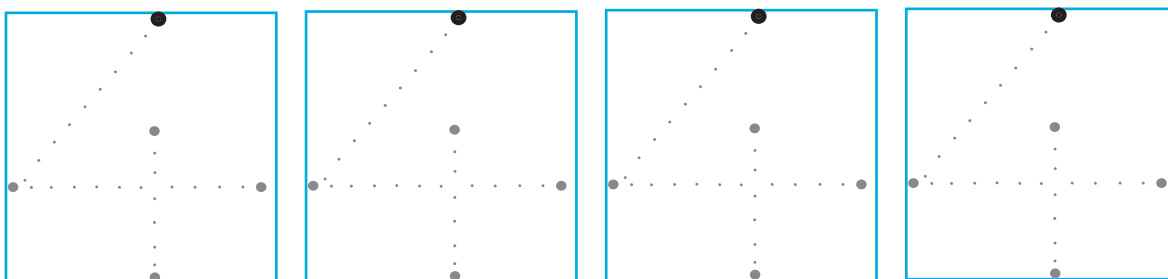
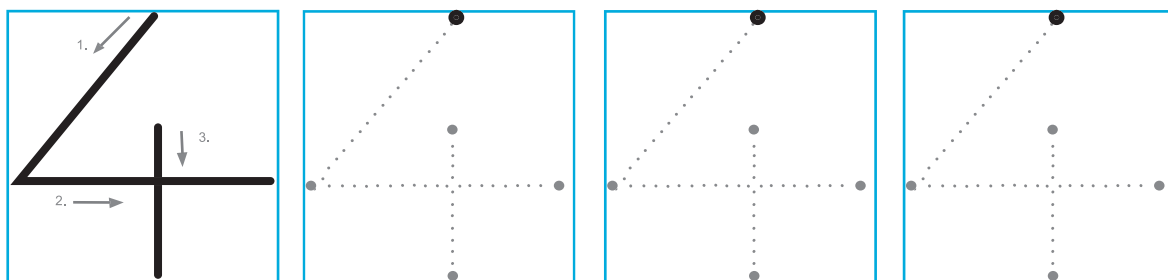

Keresd meg amiből 4 van és írd alá a számjelét!

Rajzolj annyit, amennyit a szám mutat!

2	4	3	1	4	2

Írd az üres négyzetekbe, hogy mennyit látsz a képen!



Folytasd! Indulj a kezdőponttól! Írd át többször a számokat!

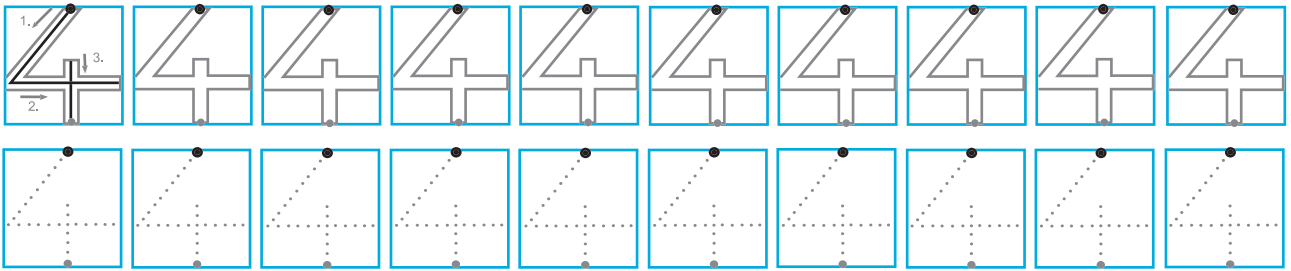

Figyelj a kezdőpontra!

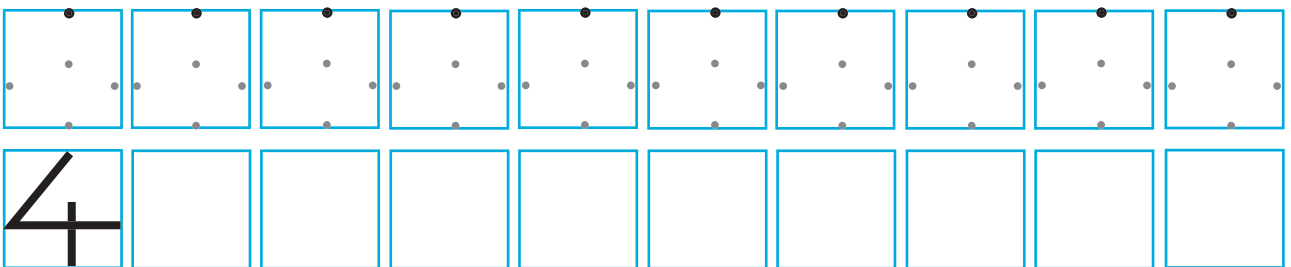

Folytasd!

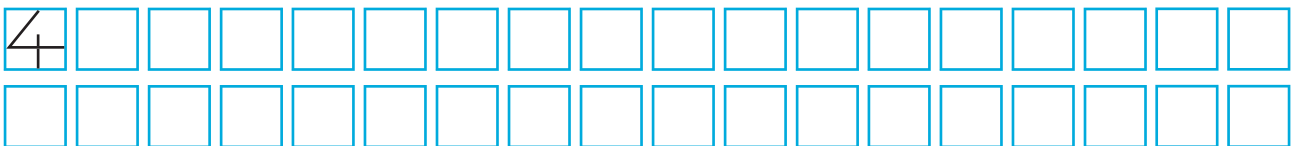

Írd át a helyes számjelet!

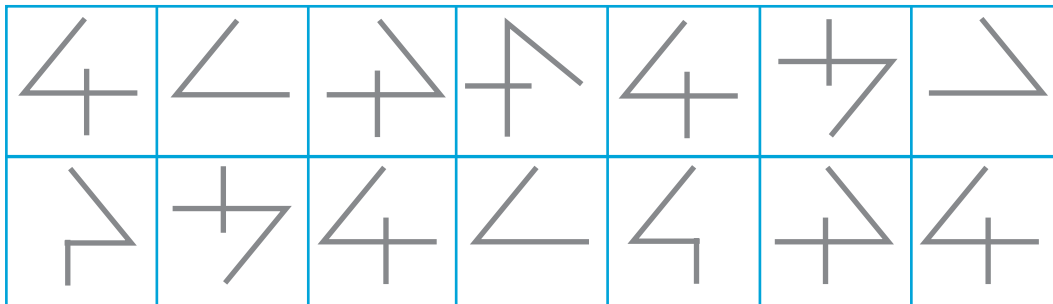

Karikázd be négyesével!

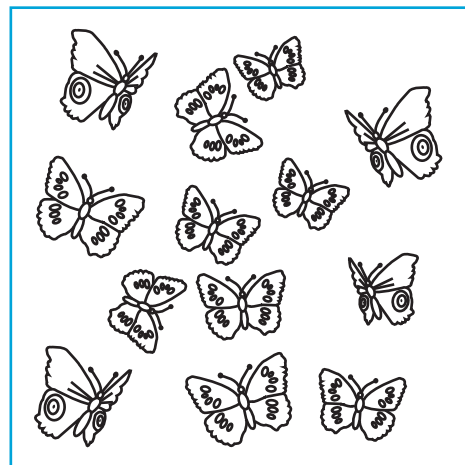
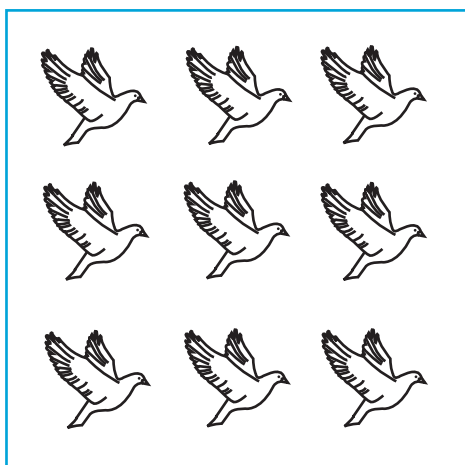

SZÁMSZIGET

Keress meg a kincshez (kincsesláda) vezető utat! Színezd ki azokat a kis részeket, amelyekben pont négyet láatsz!

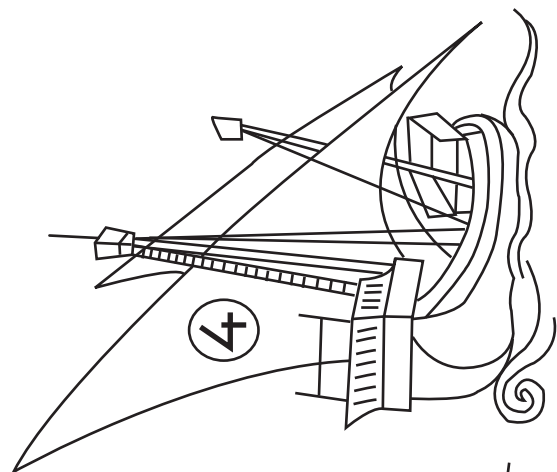

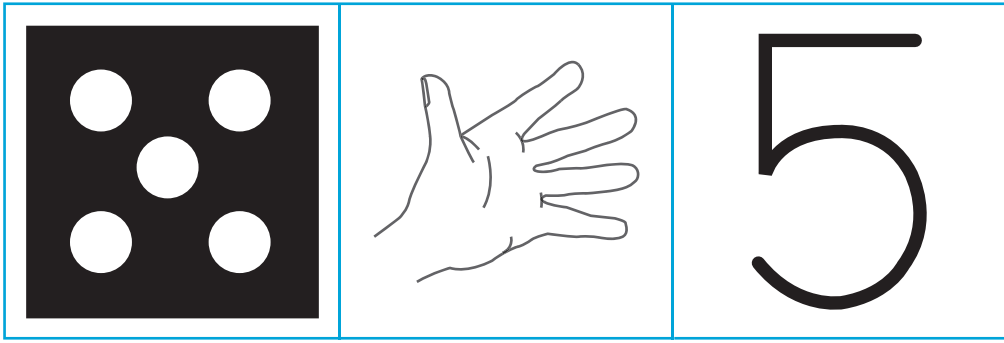

Színezd ki a rajzokat! Rajzolj valamiből ötöt az üres helyekre!

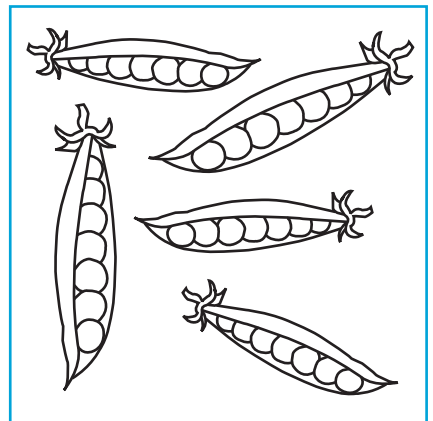
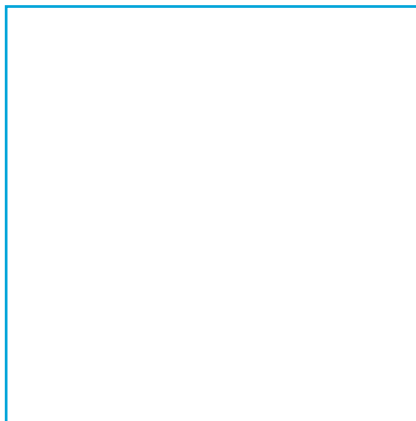
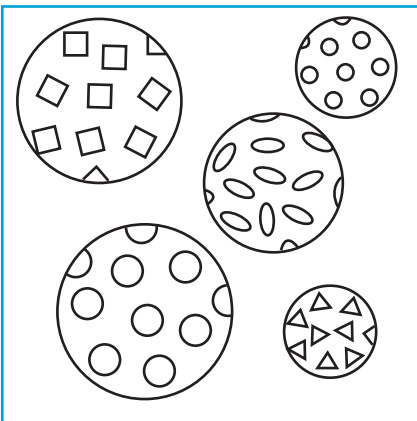
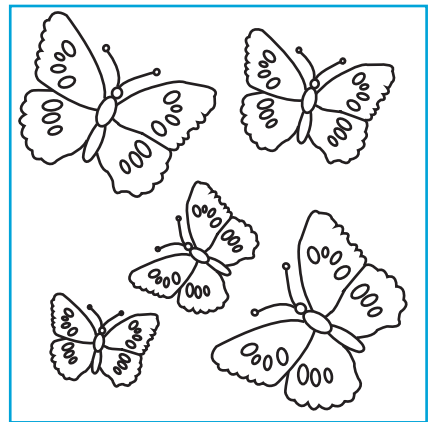
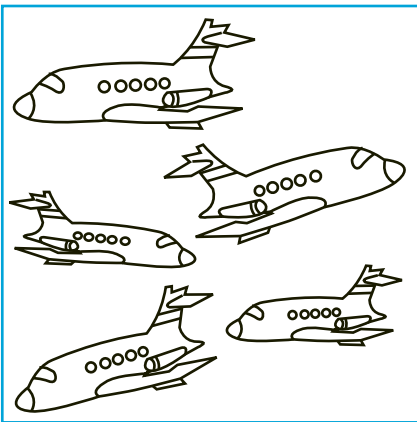
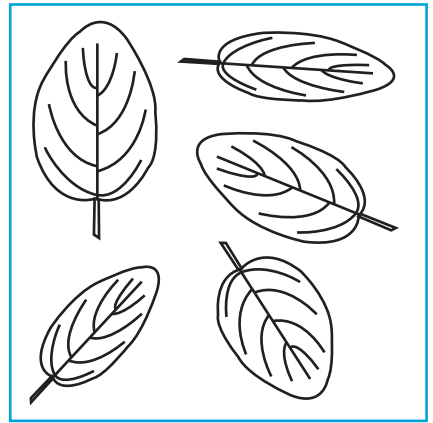
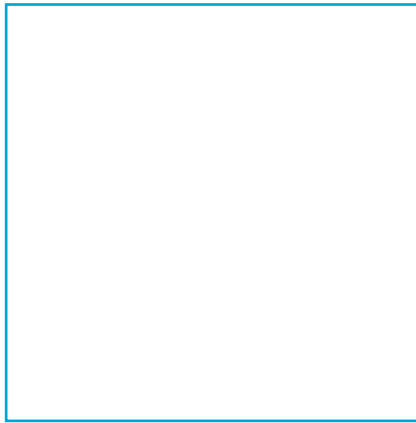
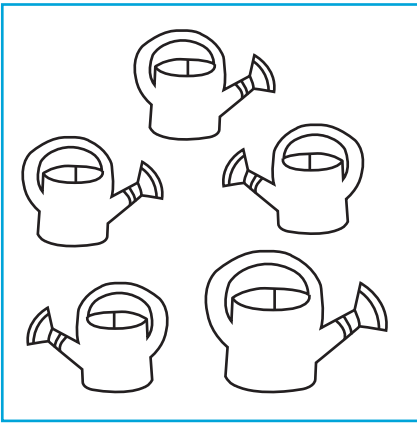

Vázold az ötös számot!
(Próbálj a vonalon belül maradni!)

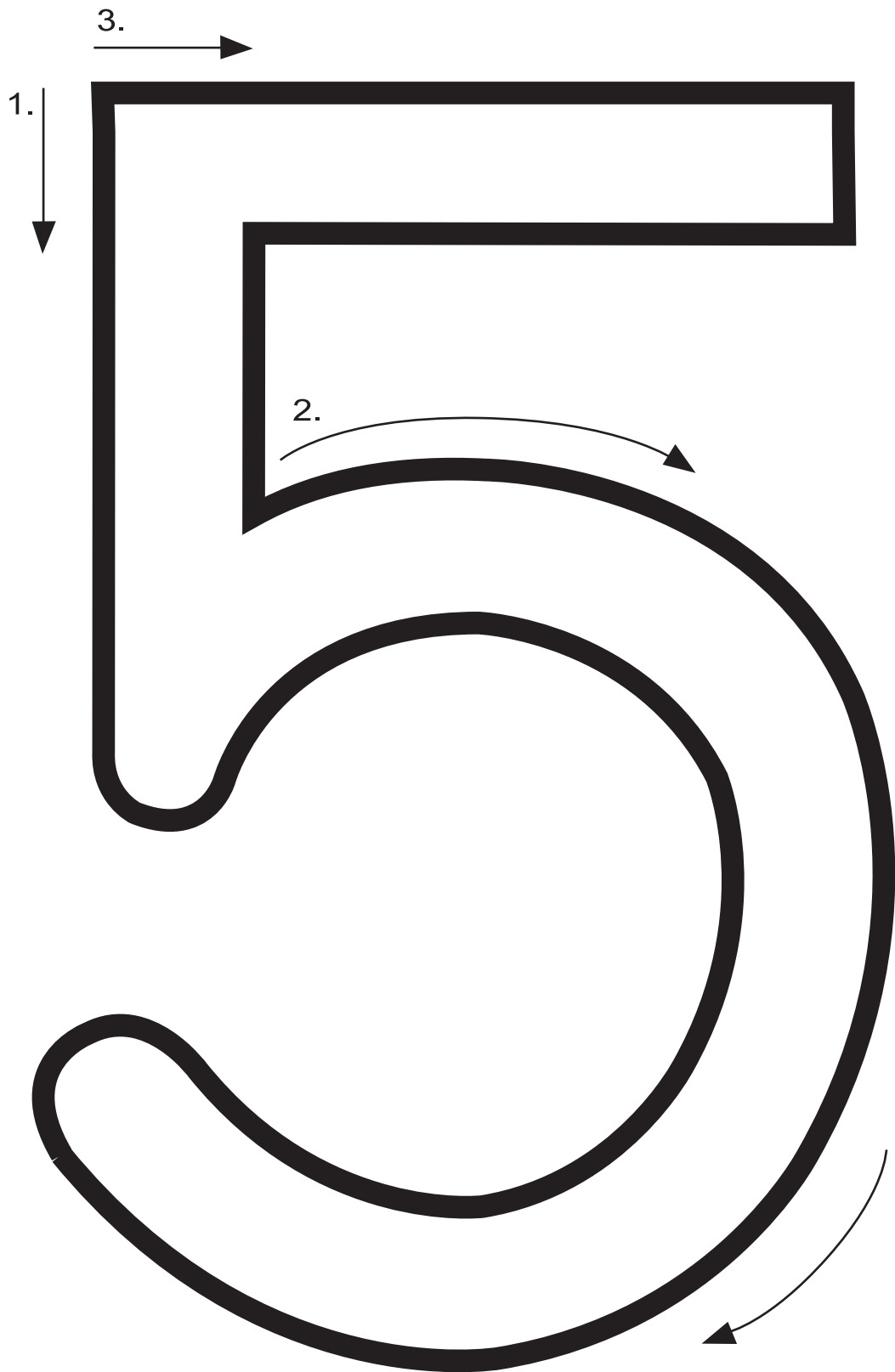

5

5

5

5

AZ ÖTÖS SZÁM VÁZOLÁSA

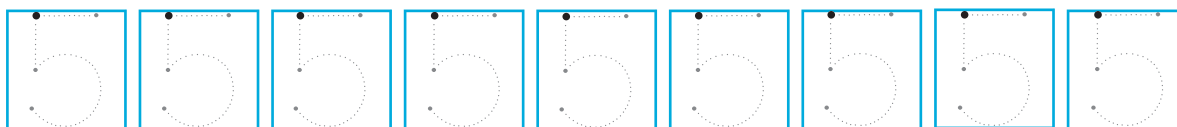
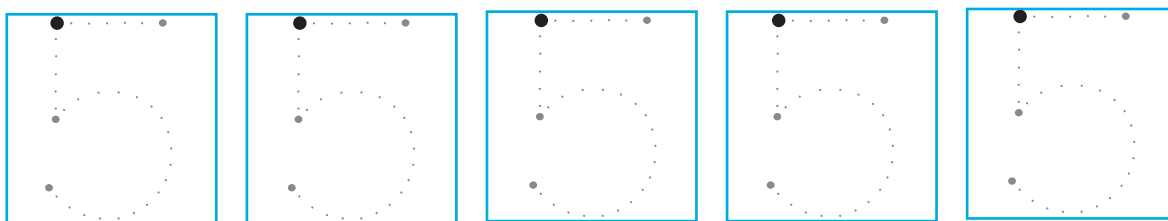
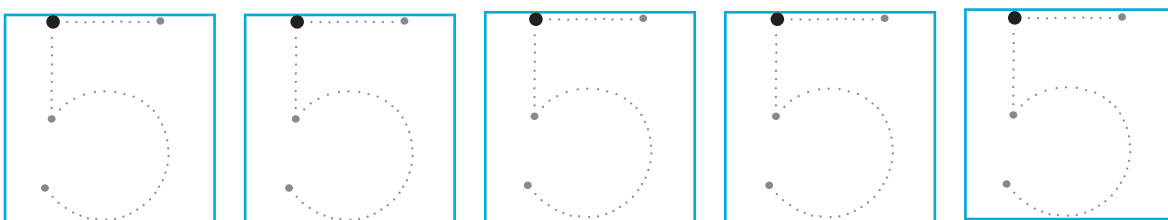
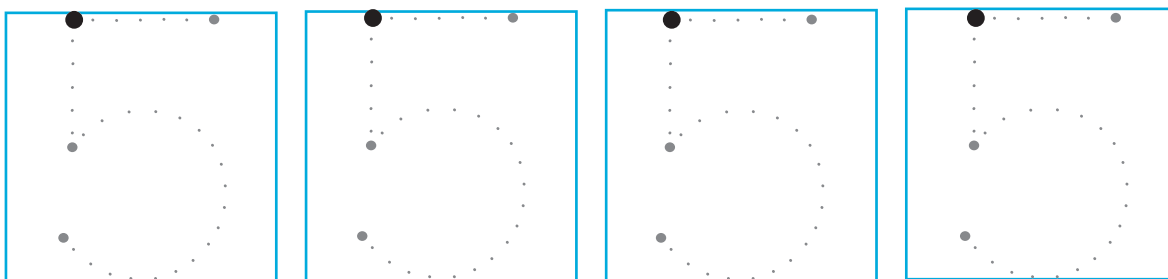
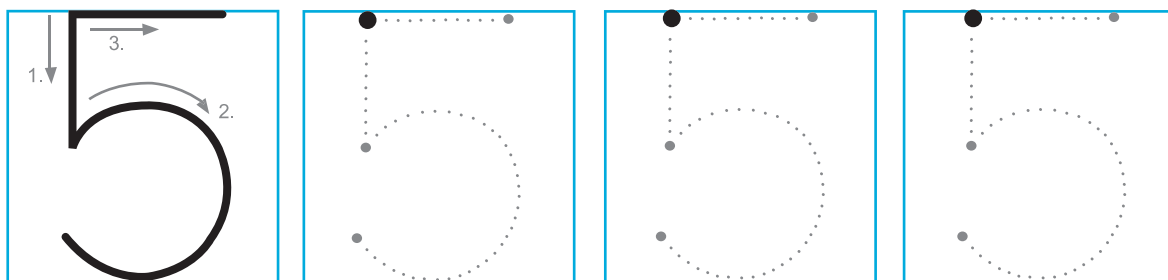

Keresd meg amiből 5 van és írd alá a számjelét!

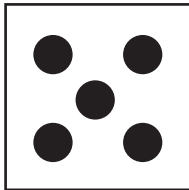
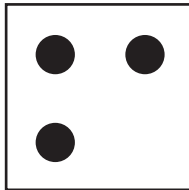
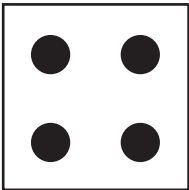
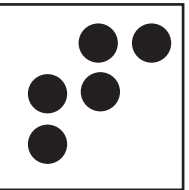
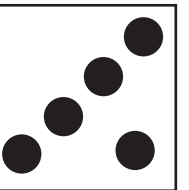
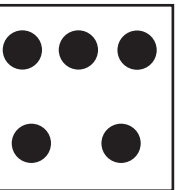
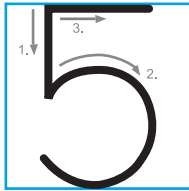

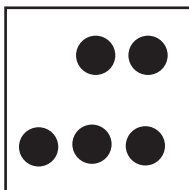
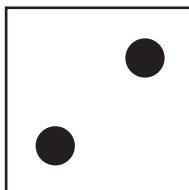
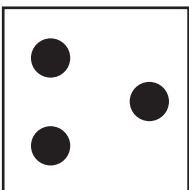
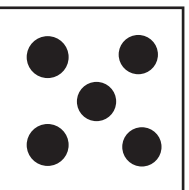
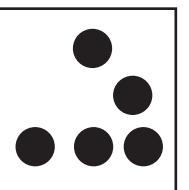
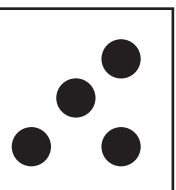

					
					

Rajzolj annyit, amennyit a szám mutat!

5	3	4	1	5	2

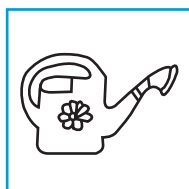
Írd az üres négyzetekbe, hogy mennyit látsz a képen!

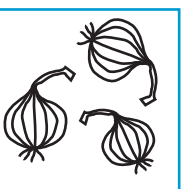
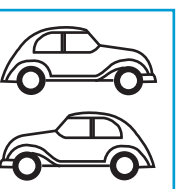



Folytasd! Indulj a kezdőponttól! Írd át többször a számokat!

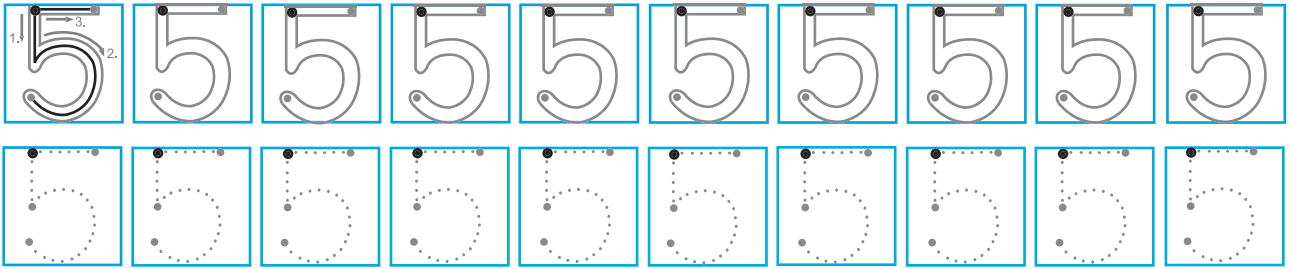

Figyelj a kezdőpontra!

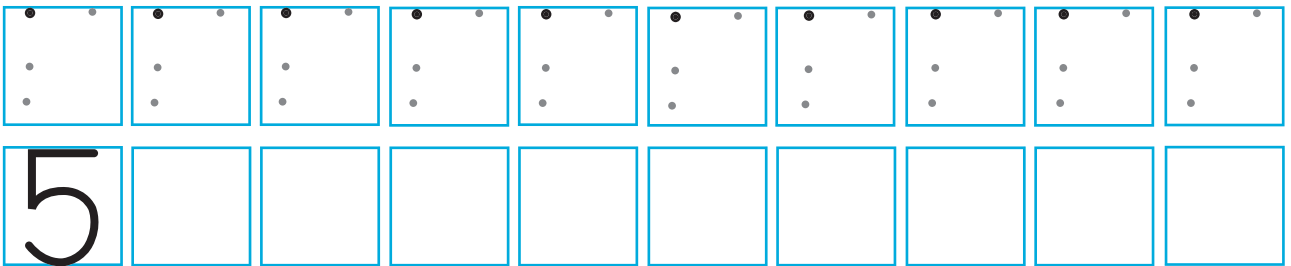

Folytasd!

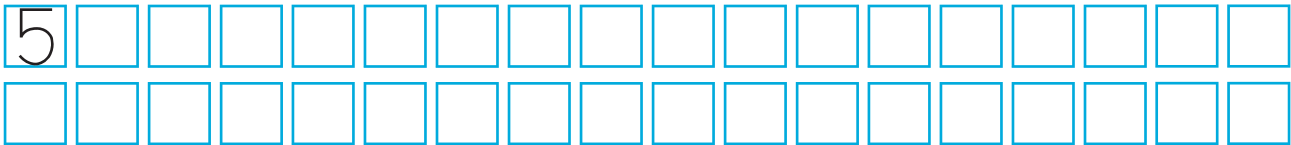

Írd át a helyes számjelet!

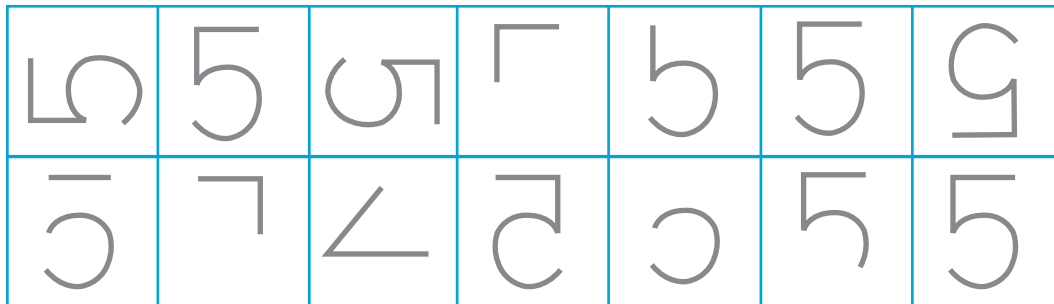

Karikázd be ötösével!

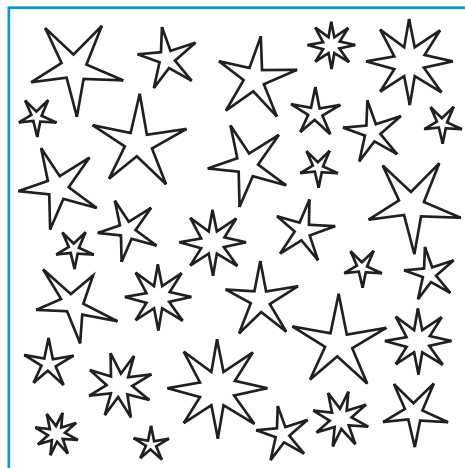
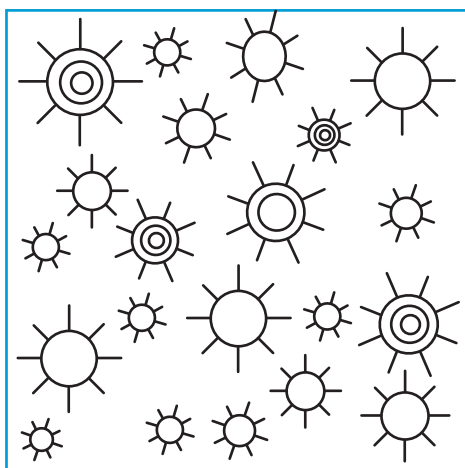

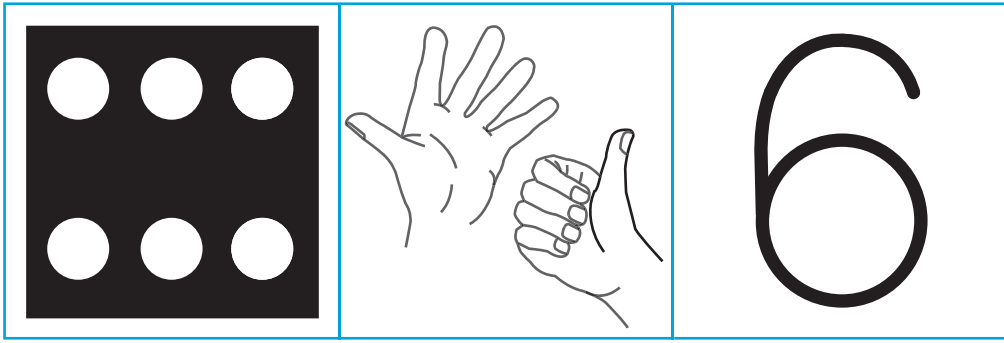

Színezd ki a rajzokat! Rajzolj valamiből hatot az üres helyekre!

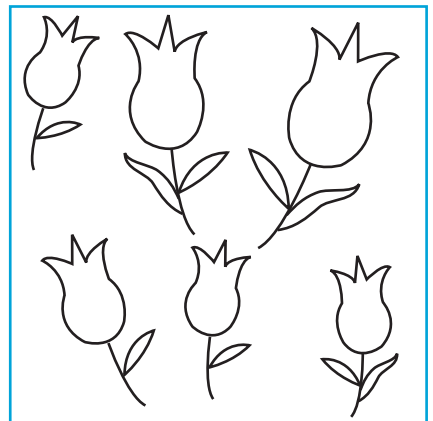
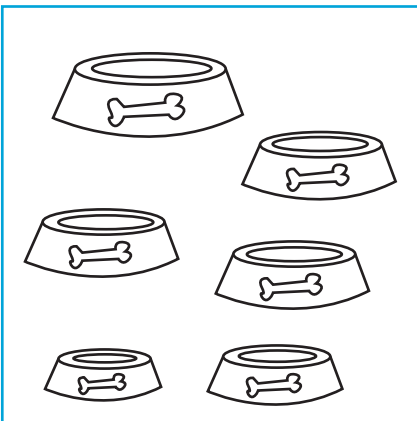
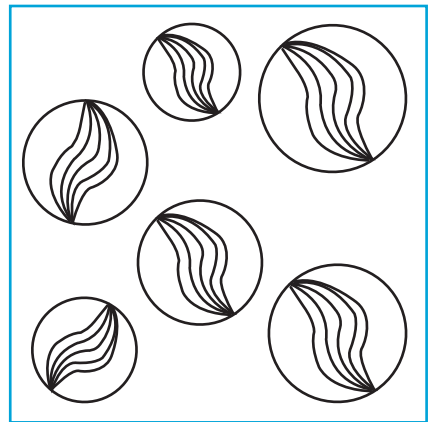
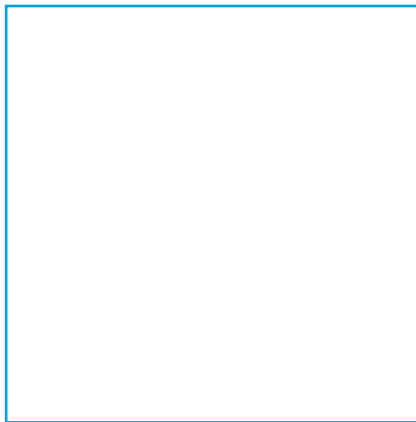
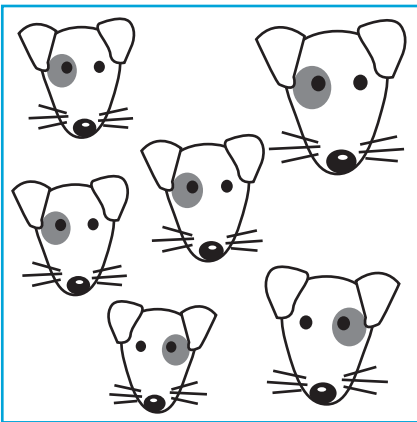
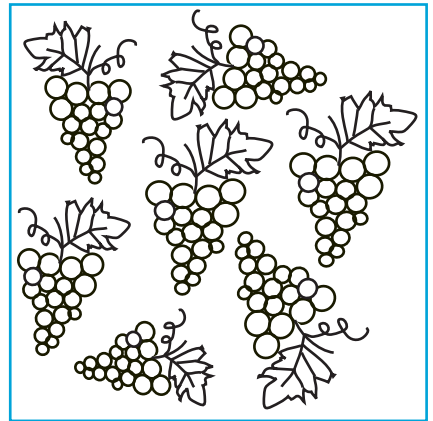
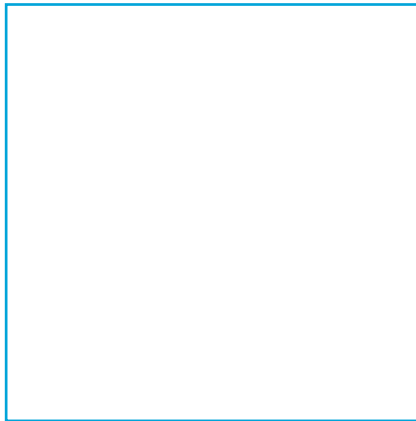
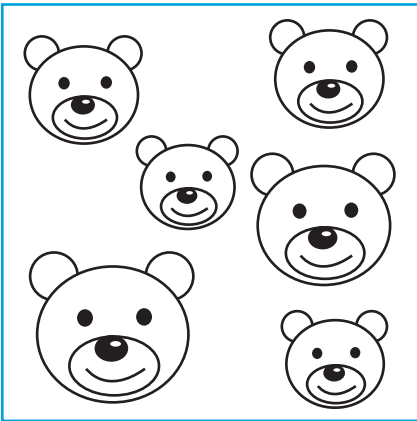

Vázold a hatos számot!
(Próbálj a vonalon belül maradni!)

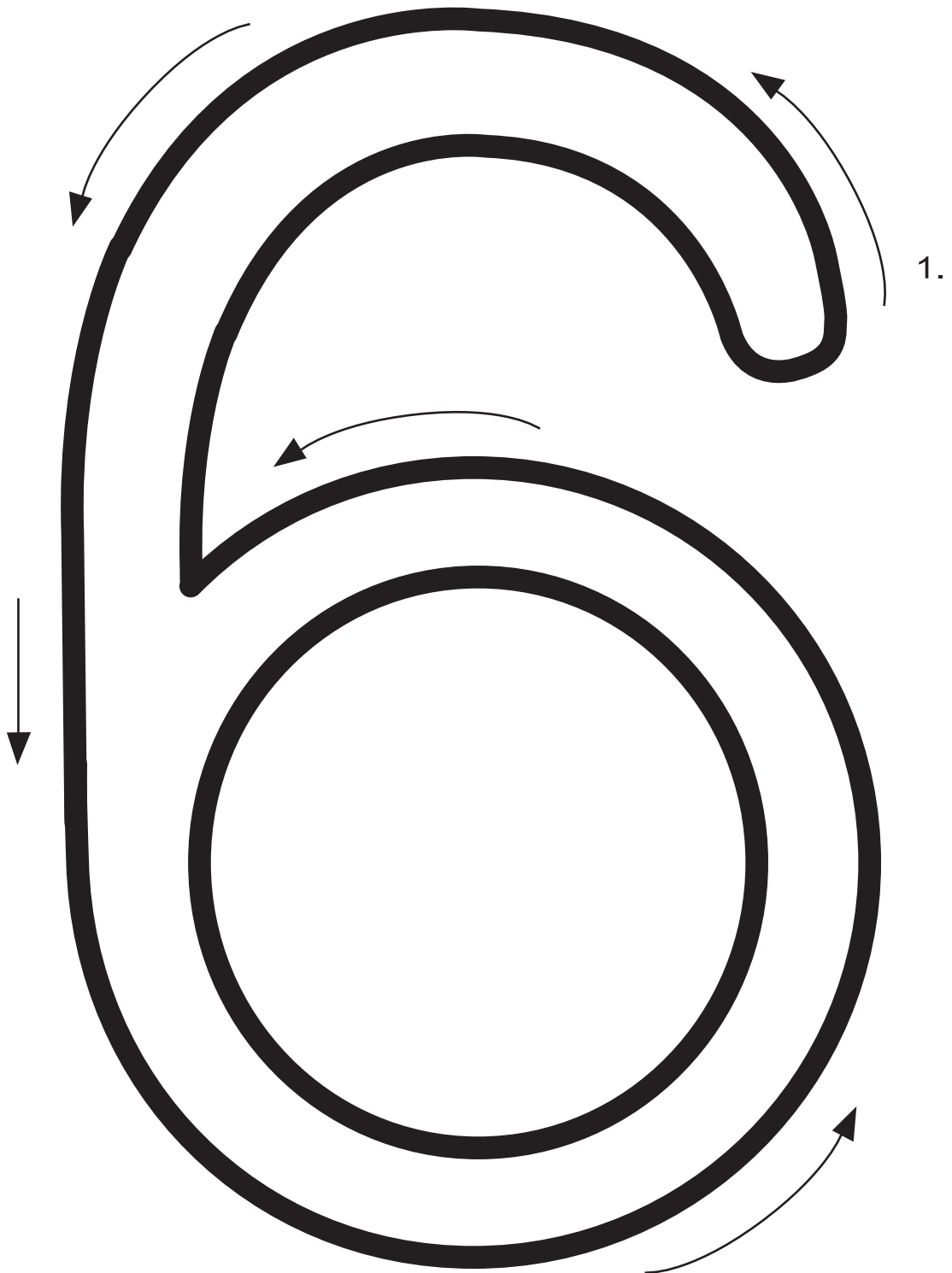

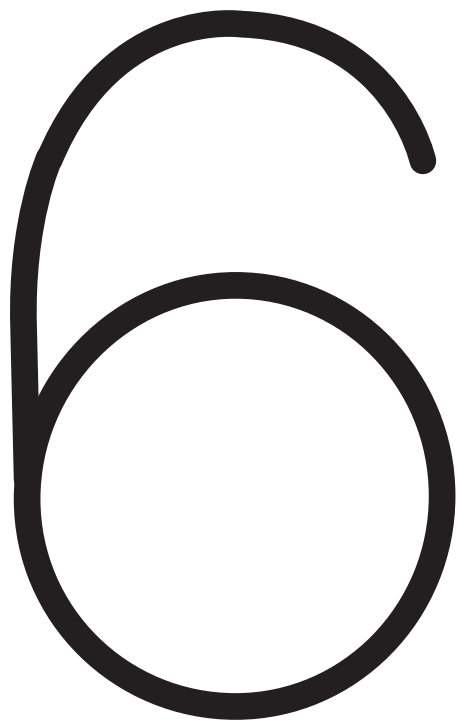
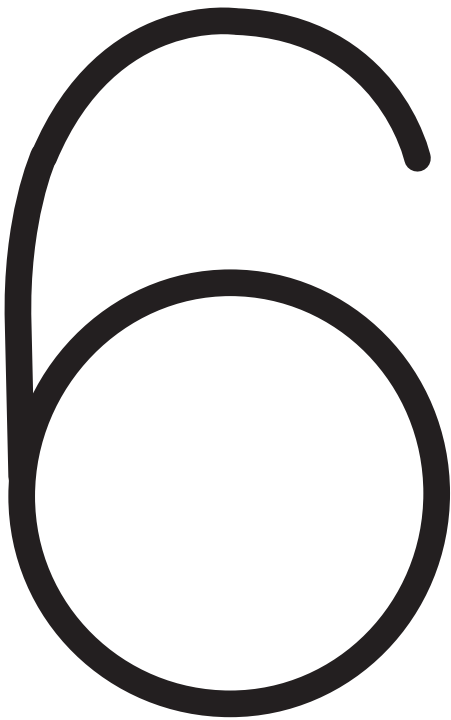
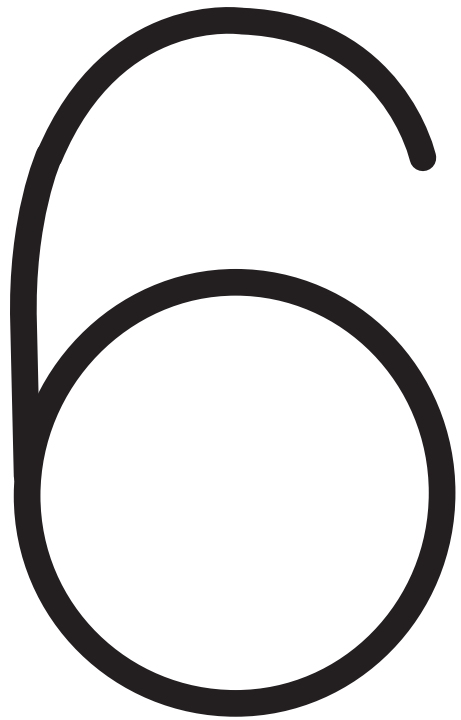
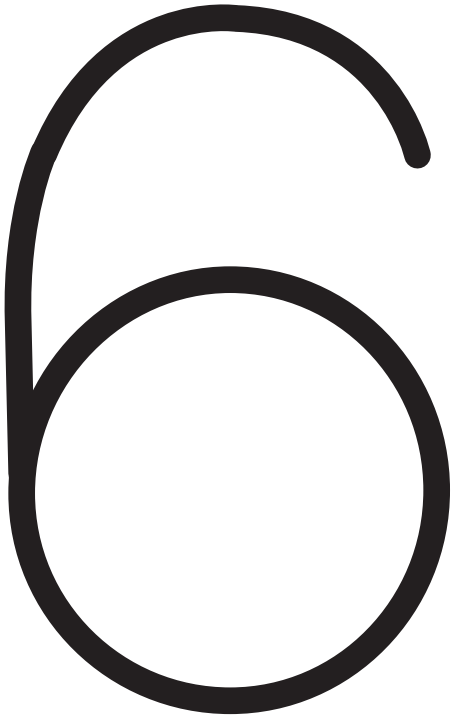

A HATOS SZÁM VÁZOLÁSA

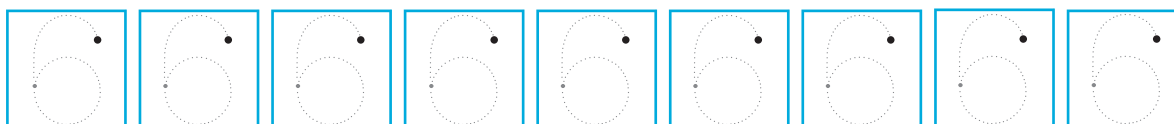
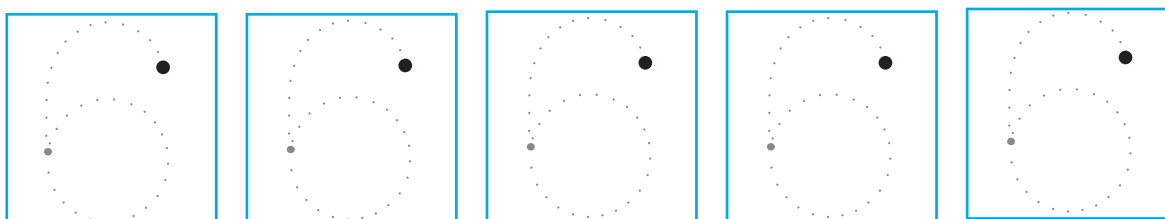
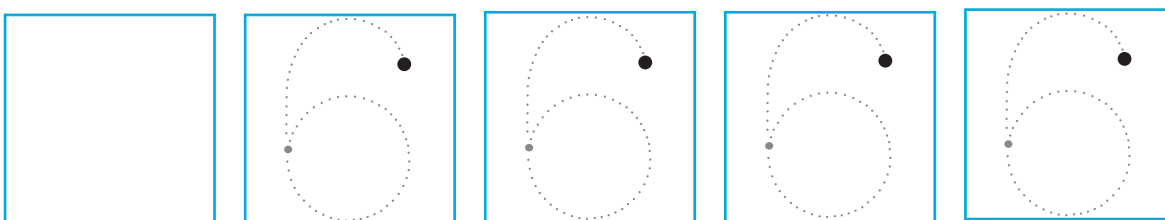
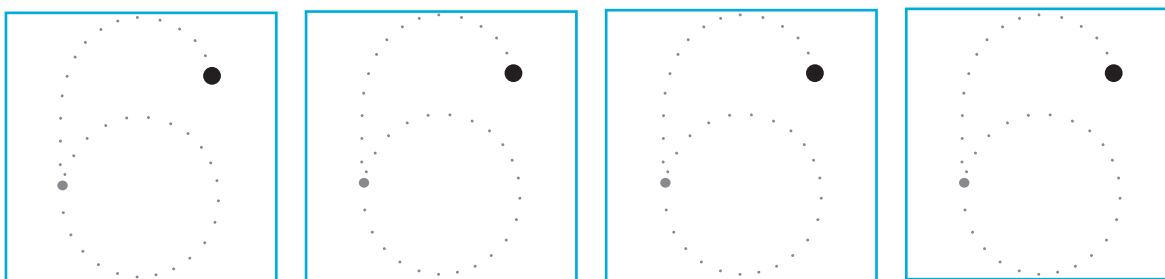
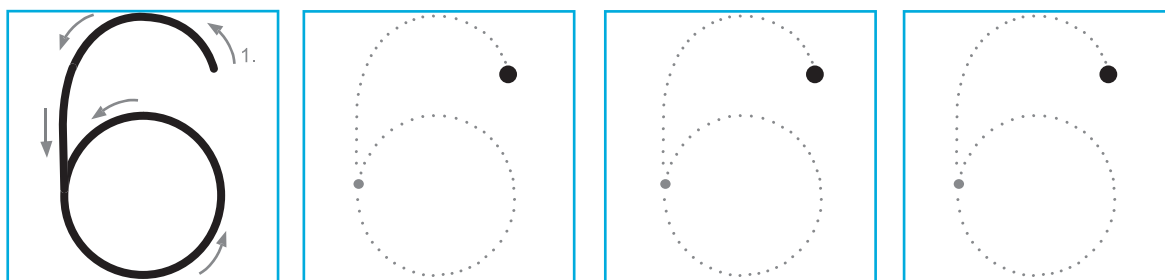

Keresd meg amiből 6 van és írd alá a számjelét!

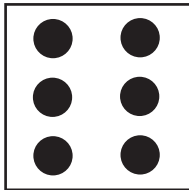
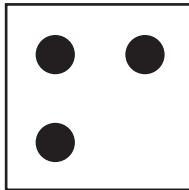
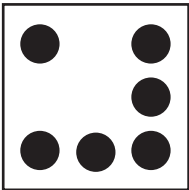
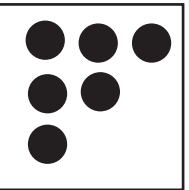
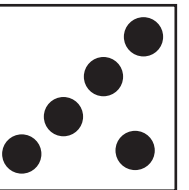
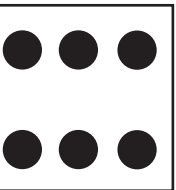
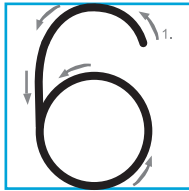

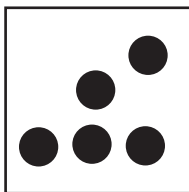
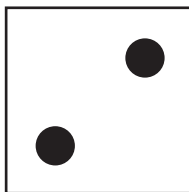
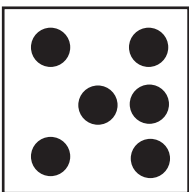
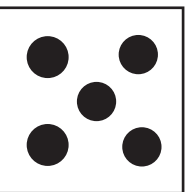
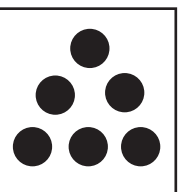
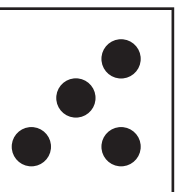

Rajzolj annyit, amennyit a szám mutat!

5	3	4	1	6	2

Írd az üres négyzetekbe, hogy mennyit látsz a képen!

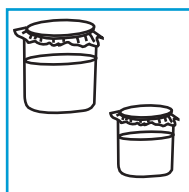
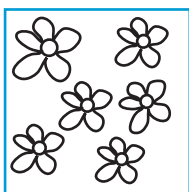
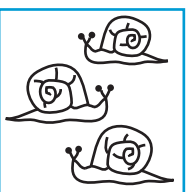

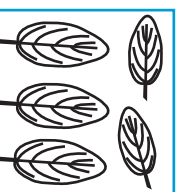
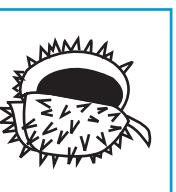

Folytasd! Indulj a kezdőponttól! Írd át többször a számokat!

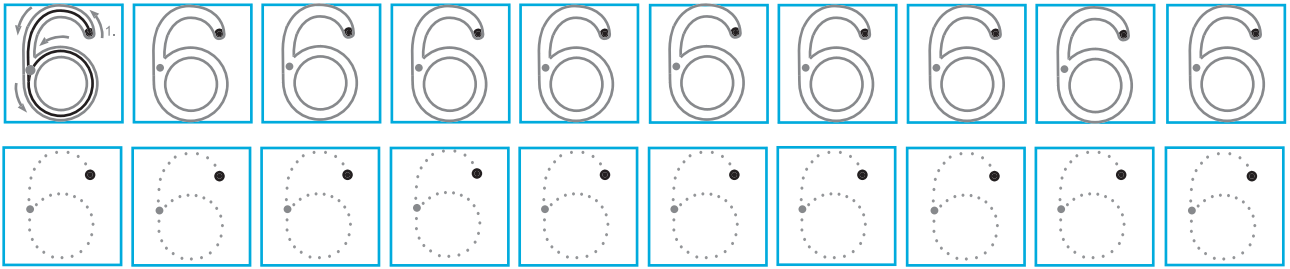

Figyelj a kezdőpontra!

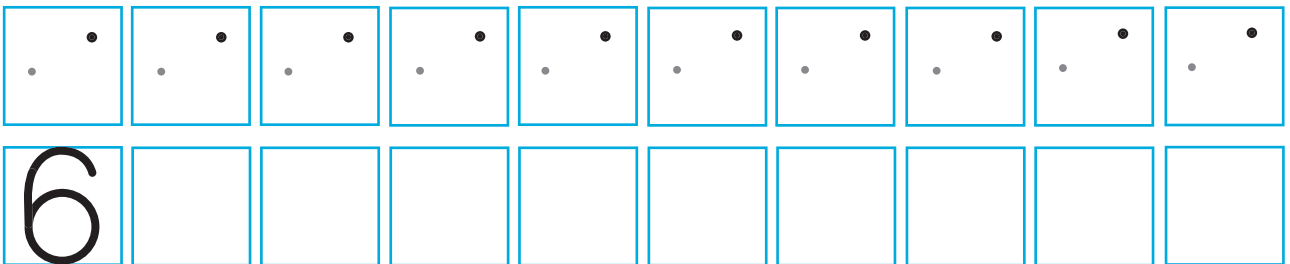

Folytasd!

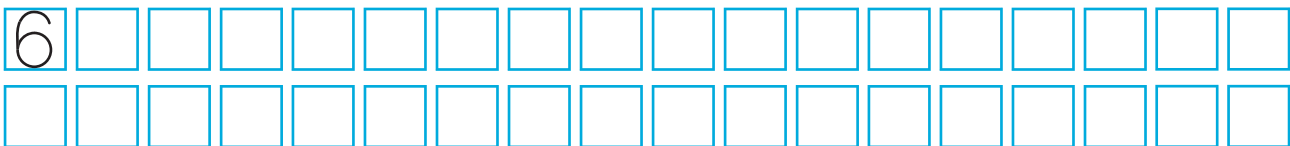

Írd át a helyes számjelet!

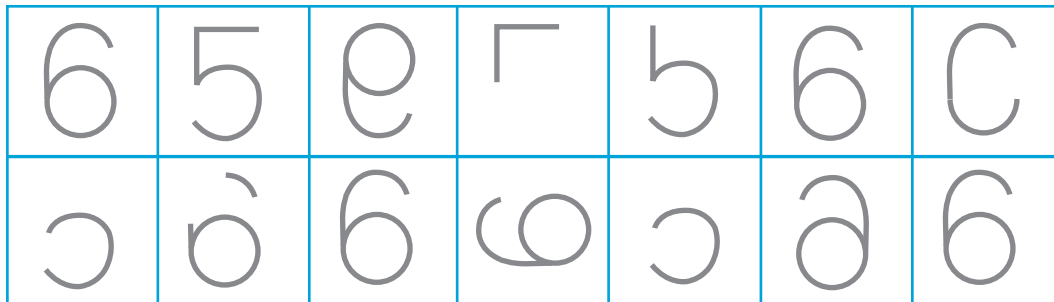

Karikázd be hatosával!

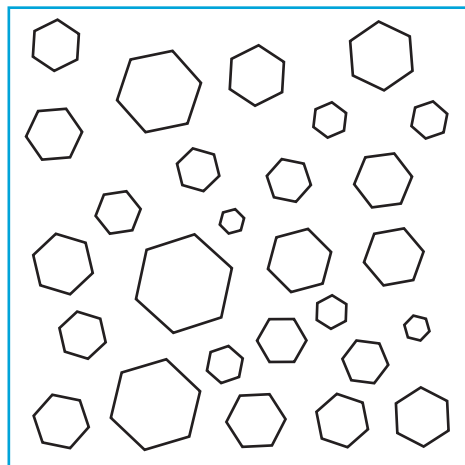
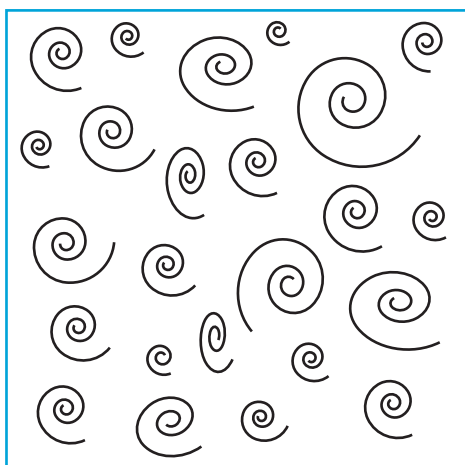

SZÁMSZIGET

Keress meg a kincshez (drágakövek) vezető utat! Színezd ki azokat a kis részeket, amelyekben pont hatot látsz!

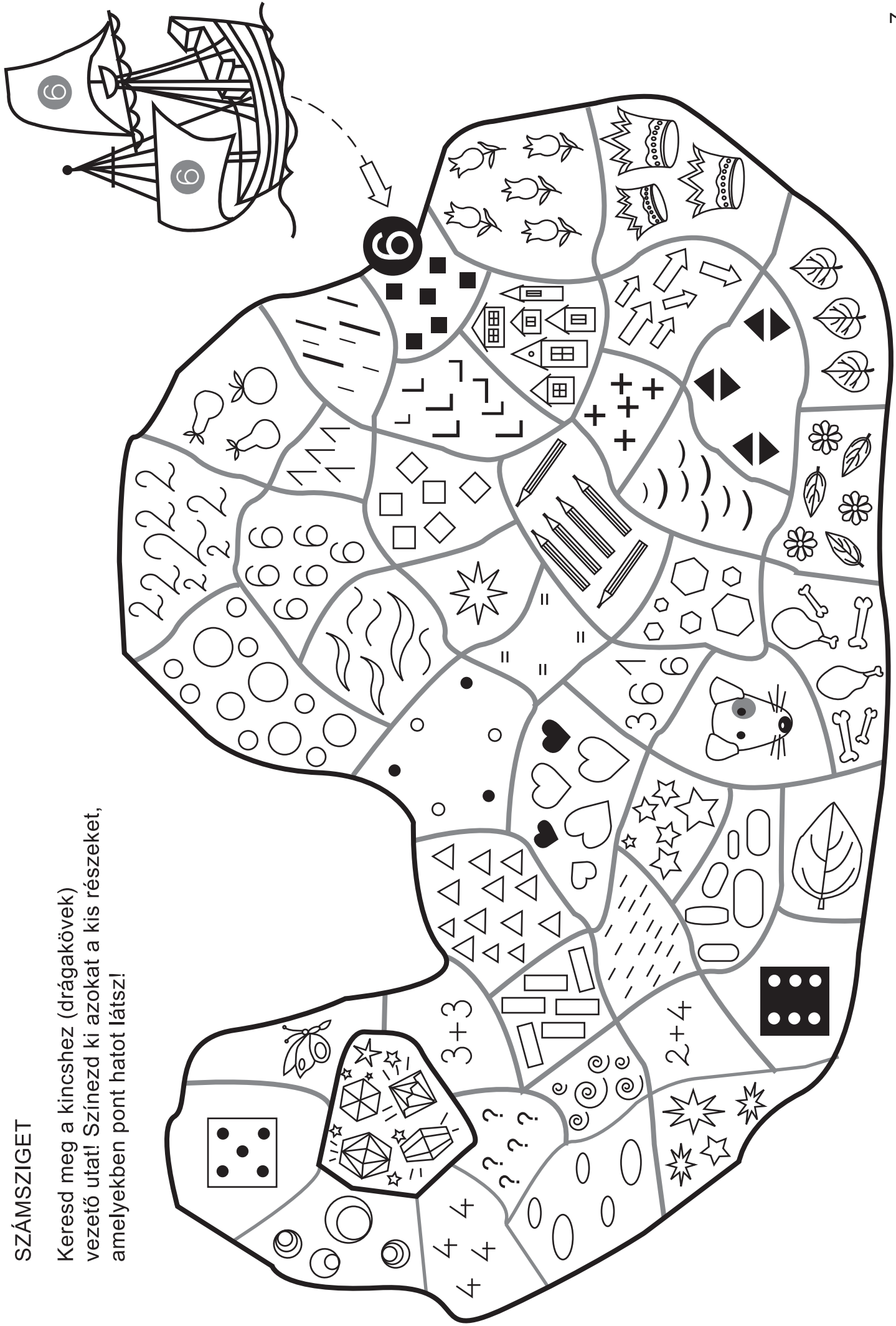

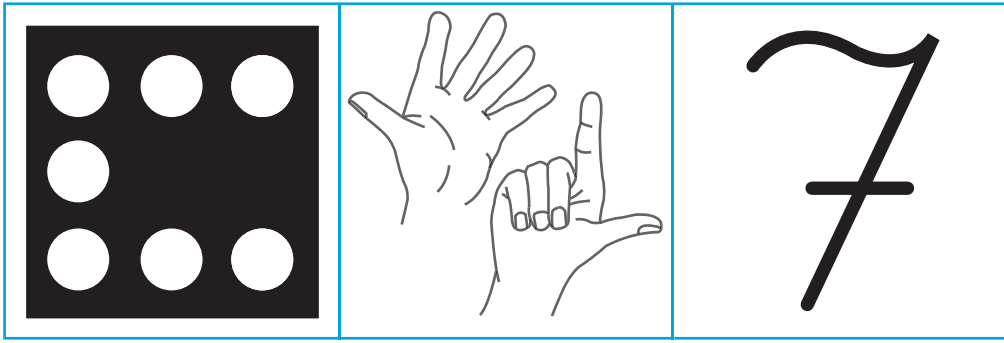

Színezd ki a rajzokat! Rajzolj valamiből hetet az üres helyekre!

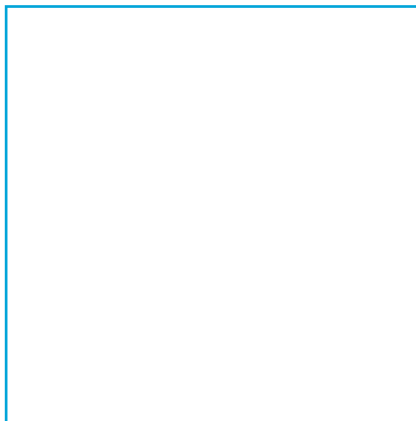
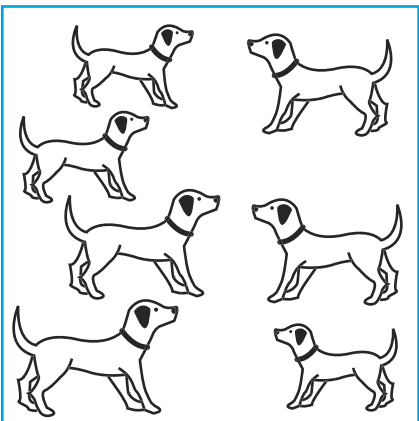
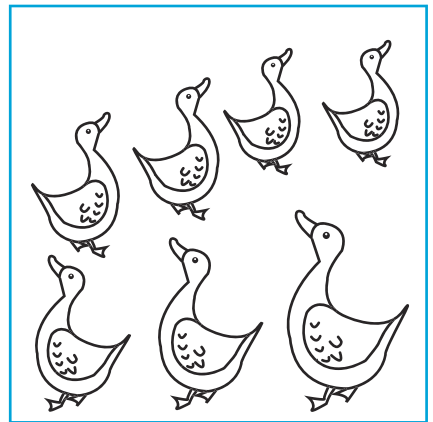
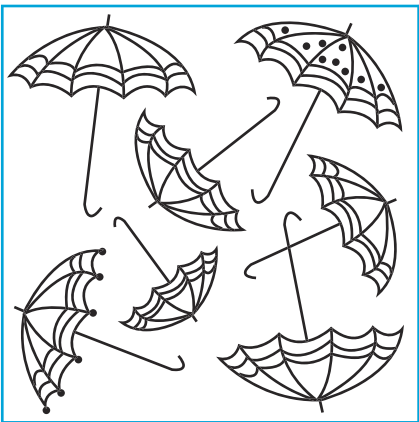
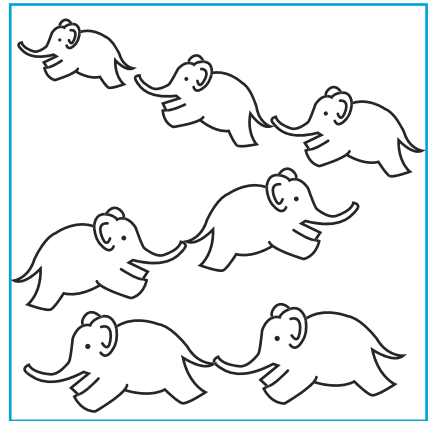
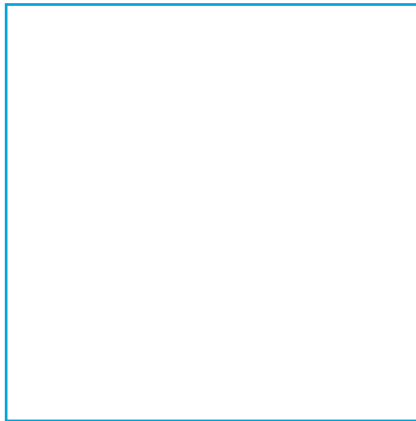

Vázold a hetes számot!
(Próbálj a vonalon belül maradni!)

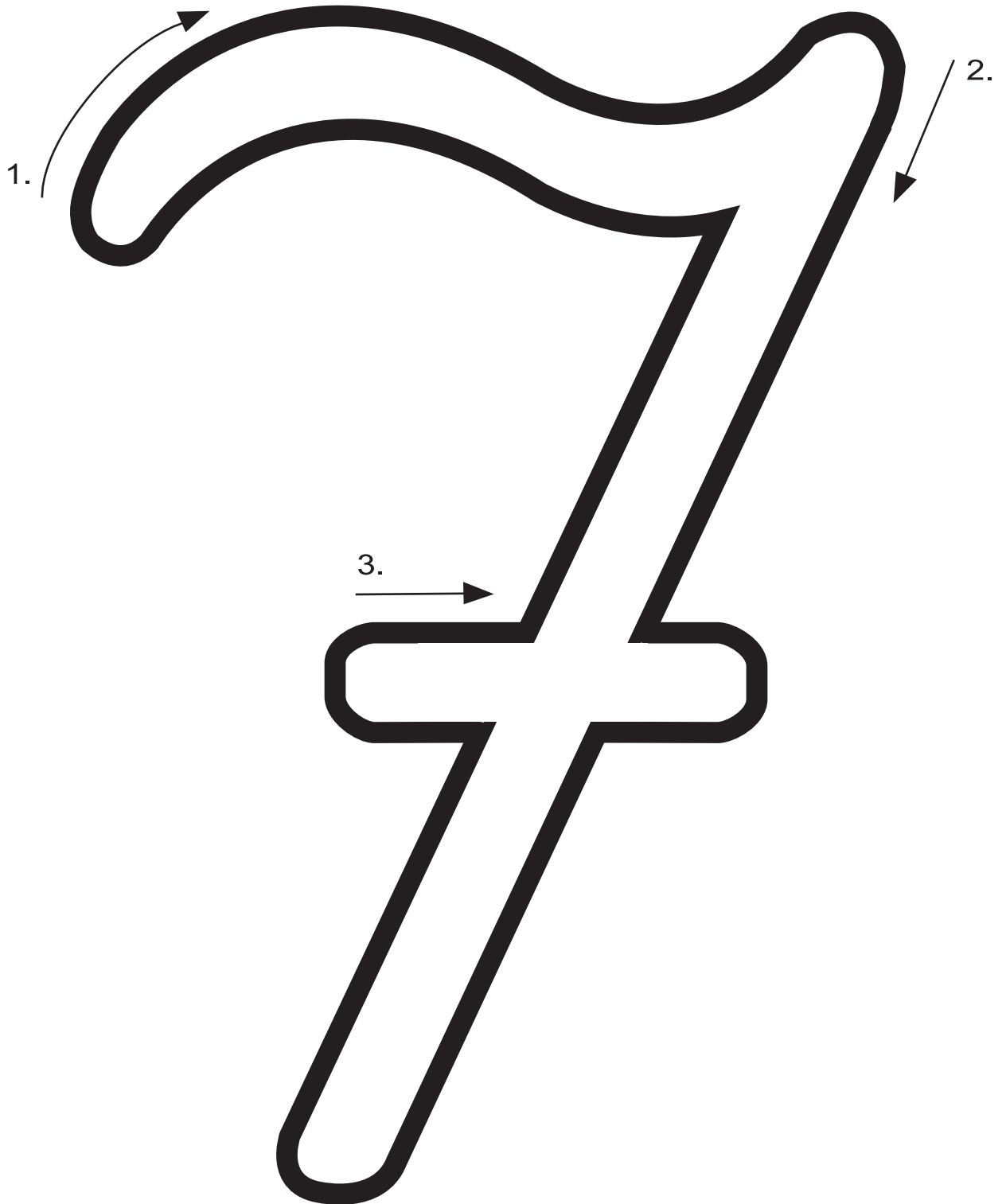

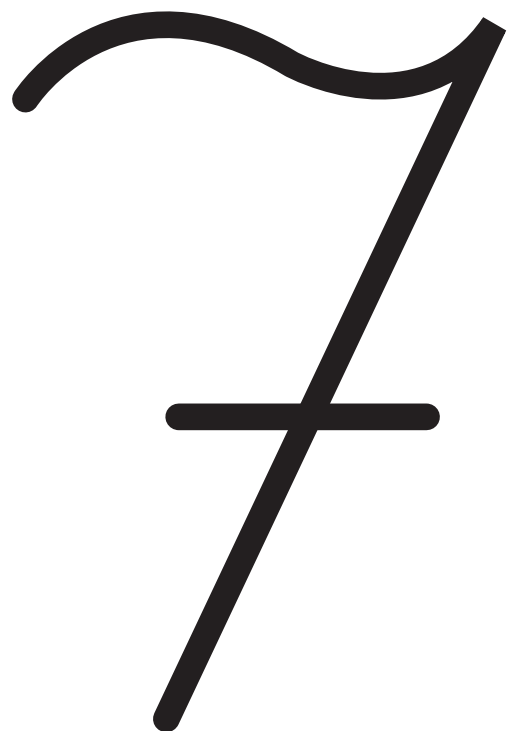
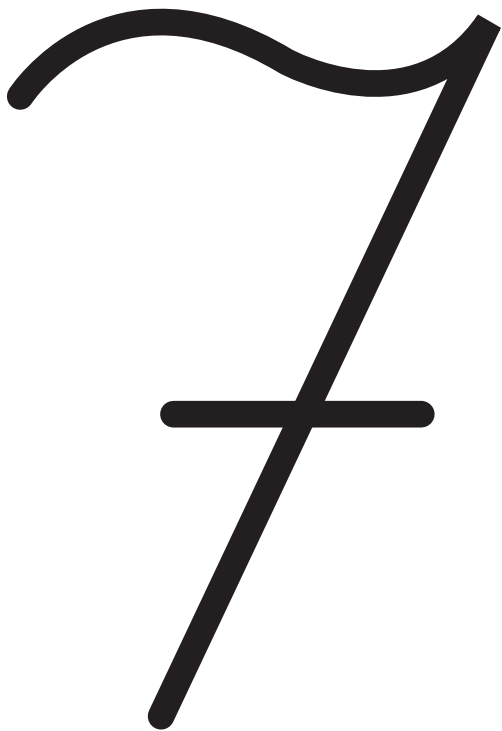
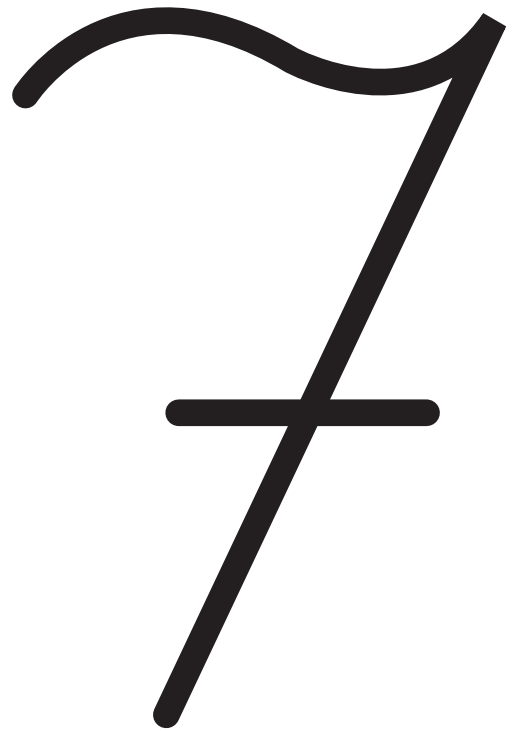
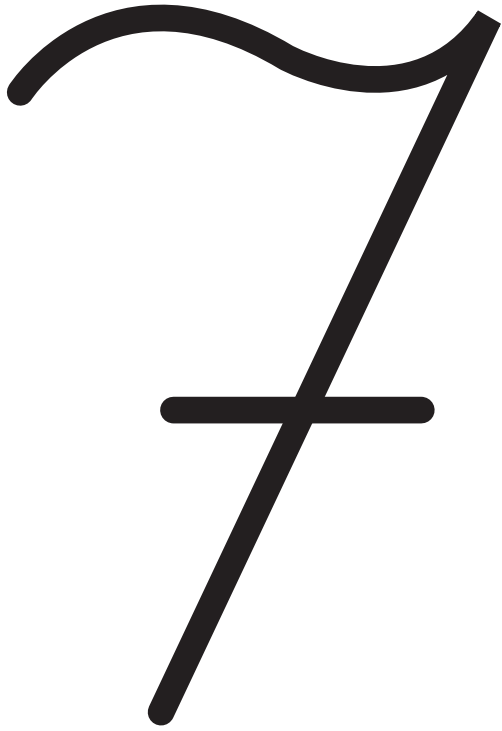

A HETES SZÁM VÁZOLÁSA

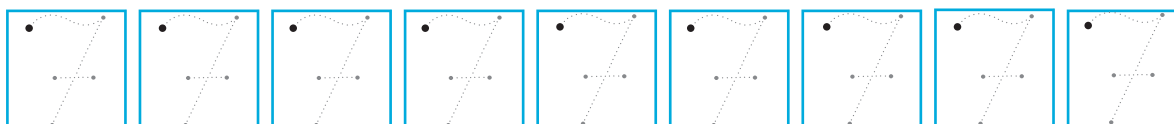
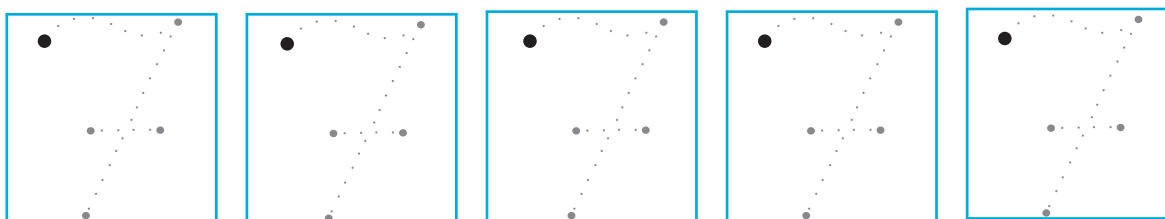
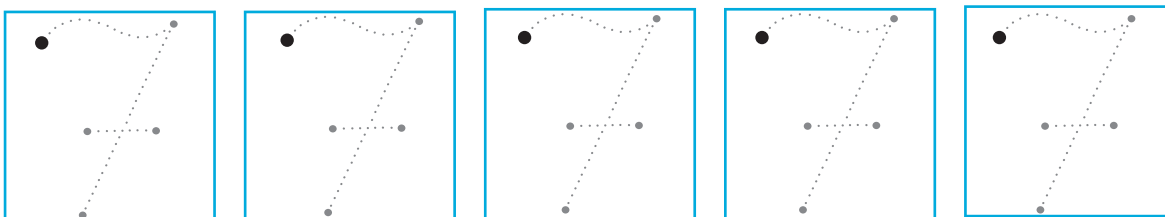
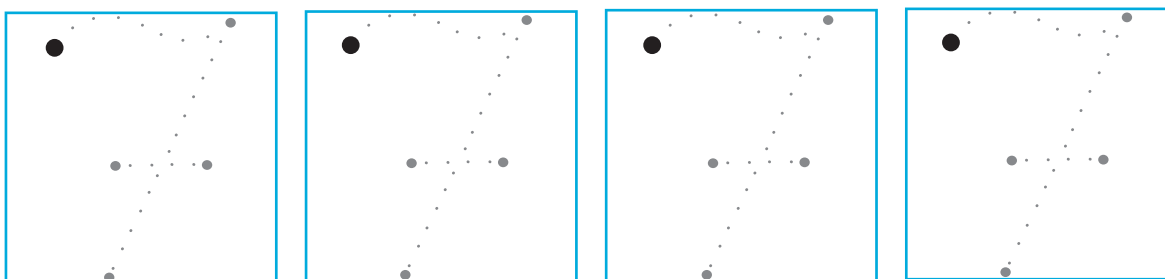
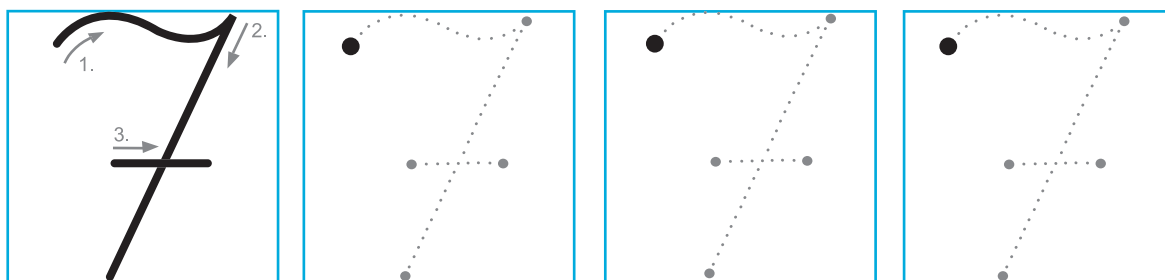

Keresd meg amiből 7 van és írd alá a számjelét!

Rajzolj annyit, amennyit a szám mutat!

5	3	4	1	7	2

Írd az üres négyzetekbe, hogy mennyit látsz a képen!



Folytasd! Indulj a kezdőponttól! Írd át többször a számokat!

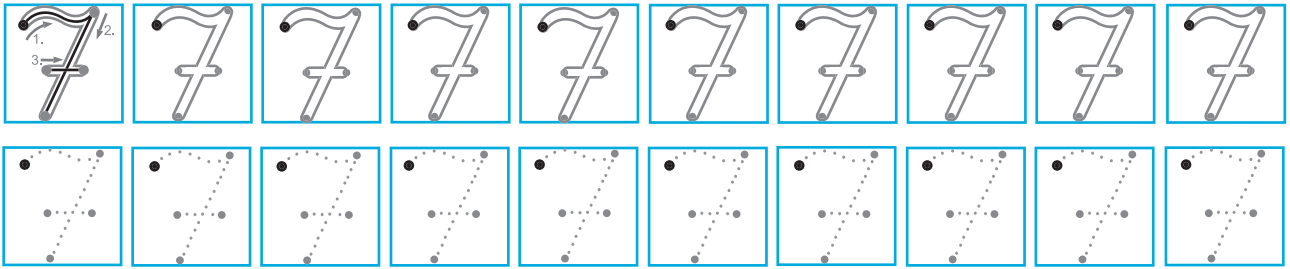

Figyelj a kezdőpontra!

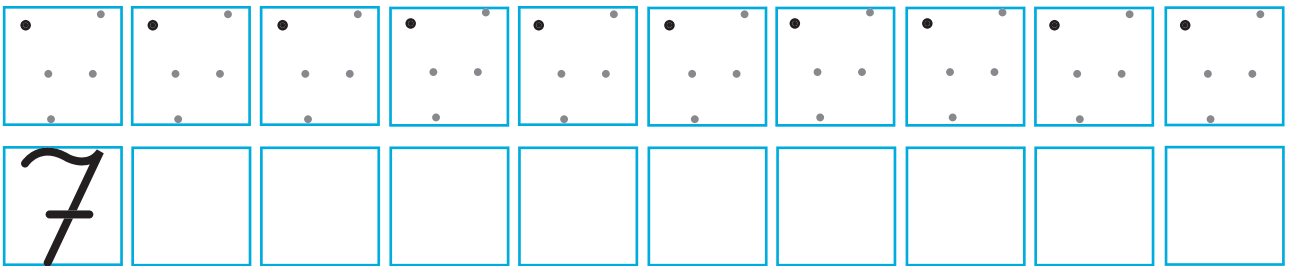

Folytasd!

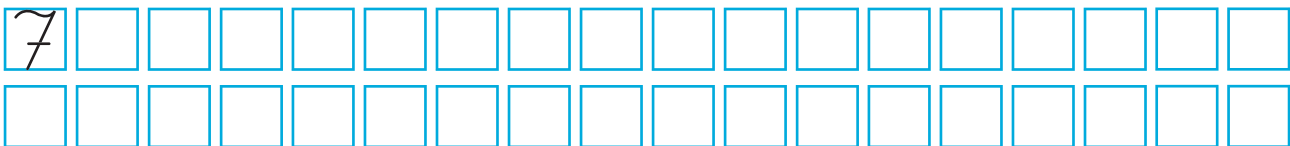

Írd át a helyes számjelet!

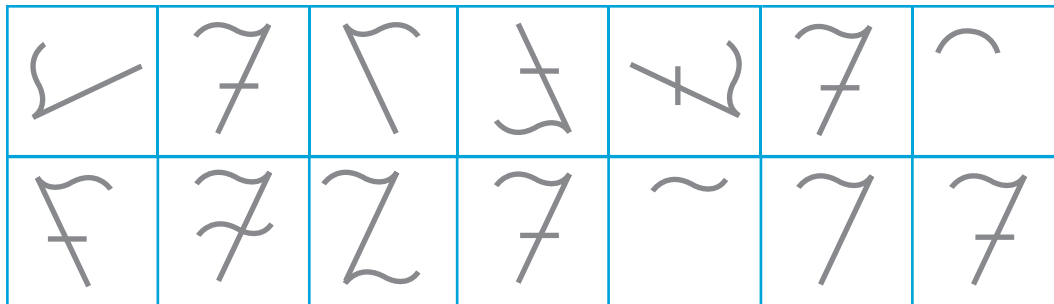

Karikázd be hetesével!

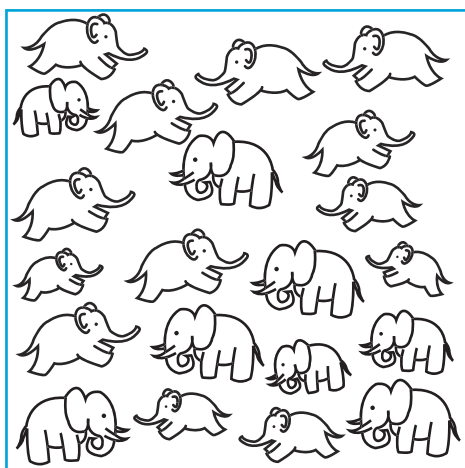

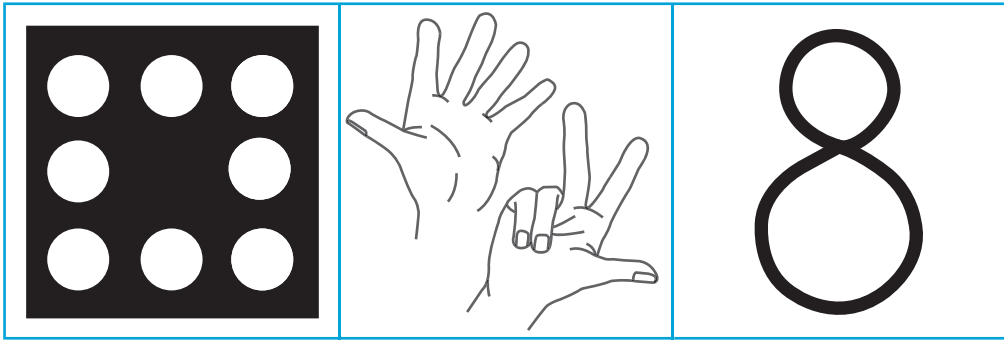

Színezd ki a rajzokat! Rajzolj valamiből nyolcat az üres helyekre!

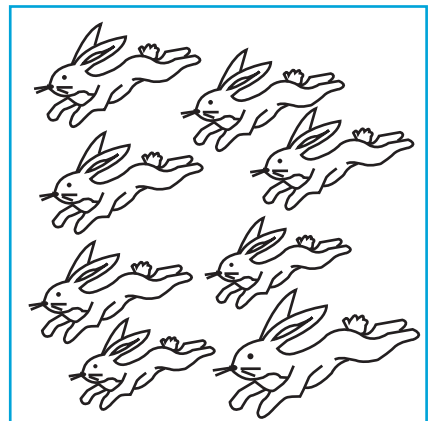
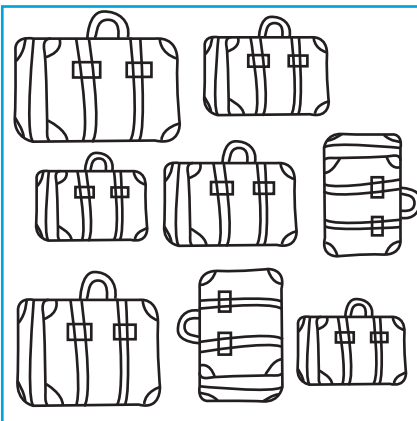
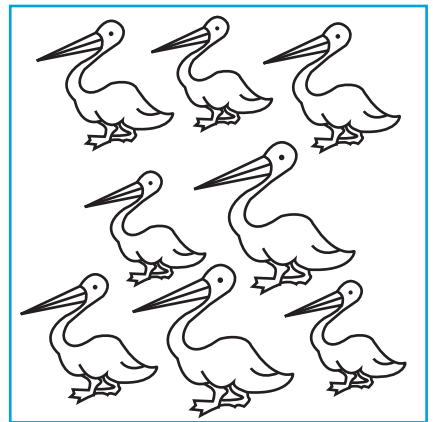
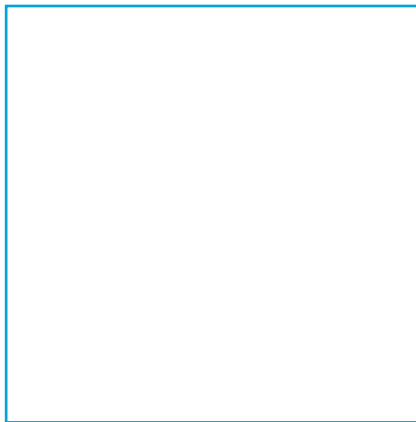
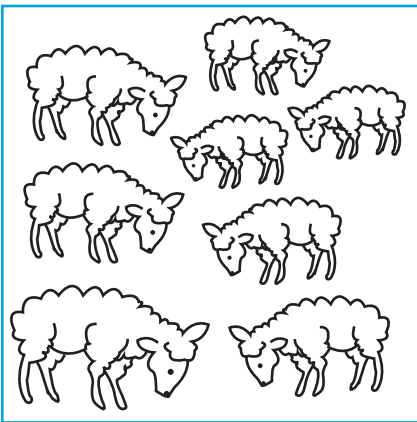
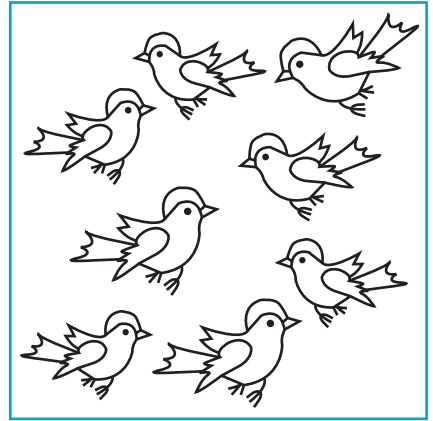
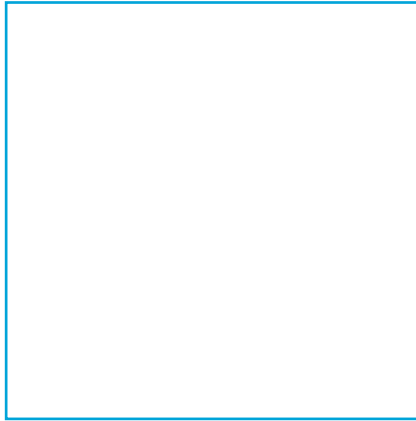
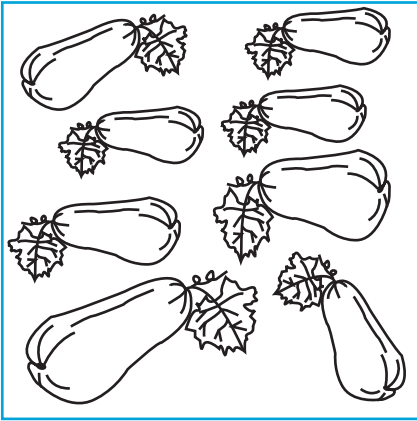

Vázold a nyolcas számot!
(Próbálj a vonalon belül maradni!)

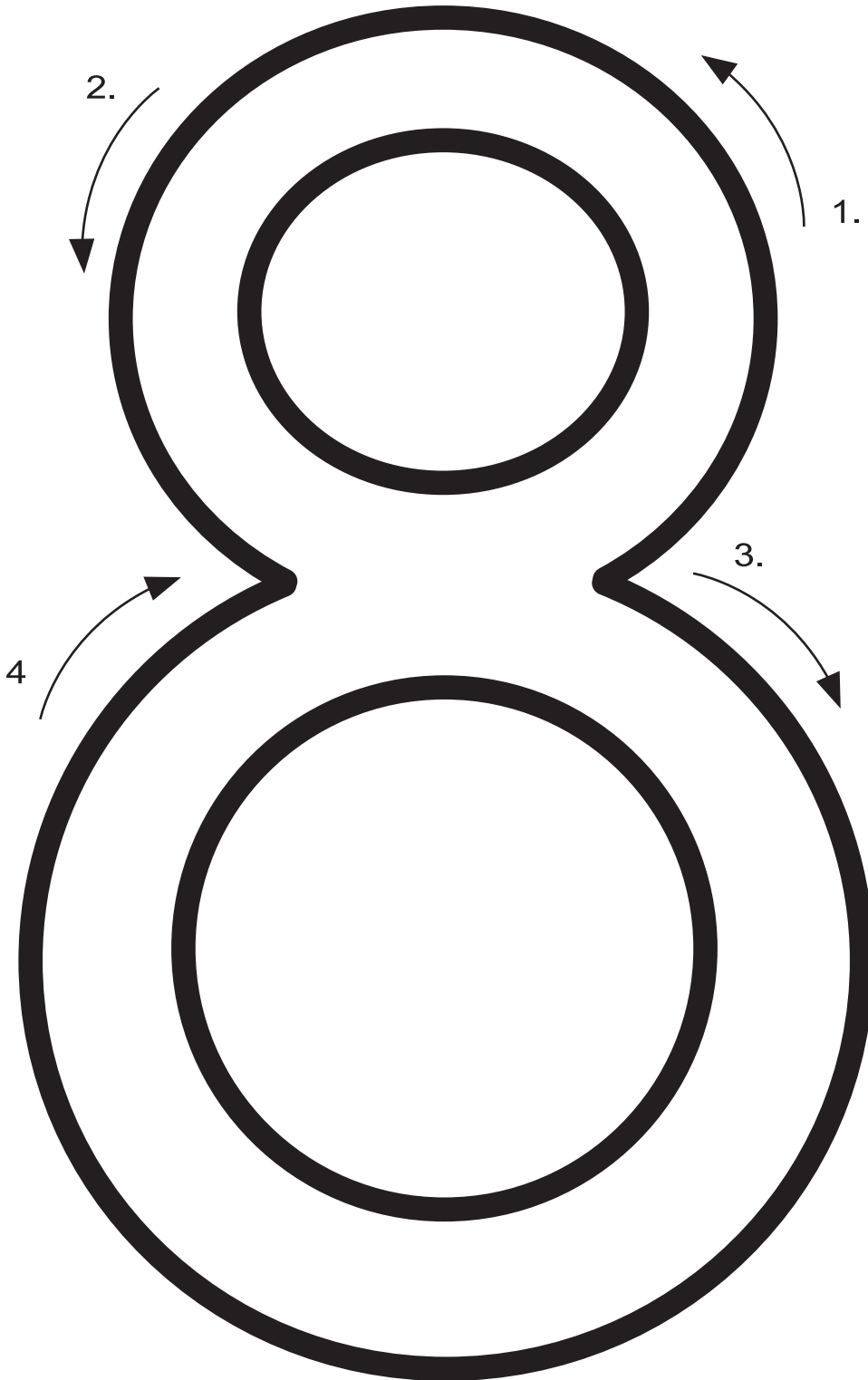

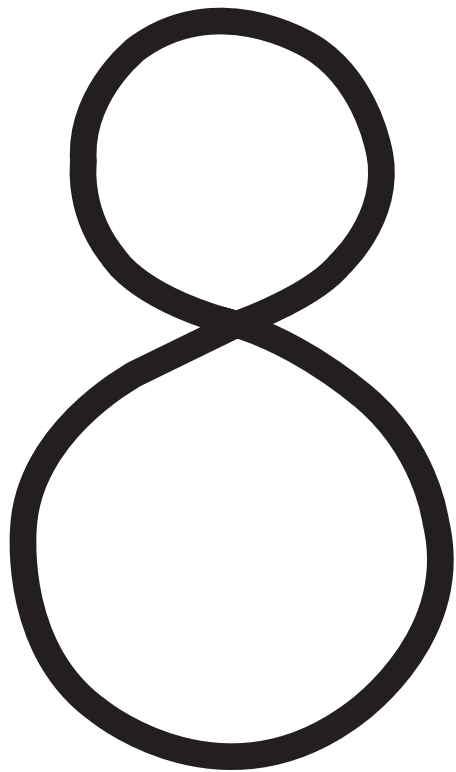
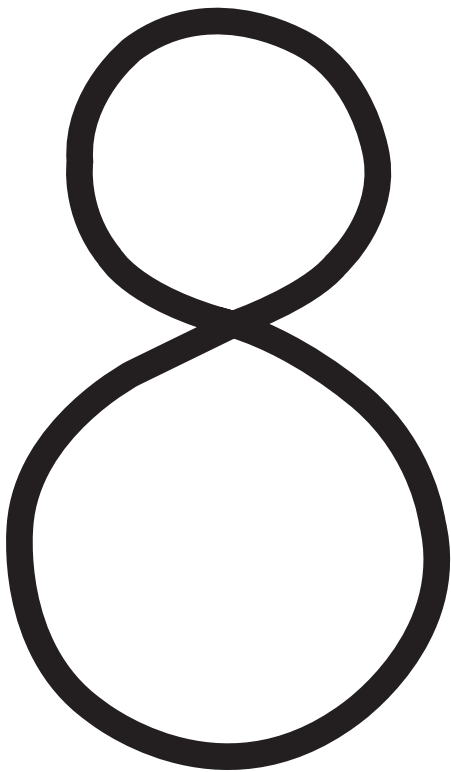
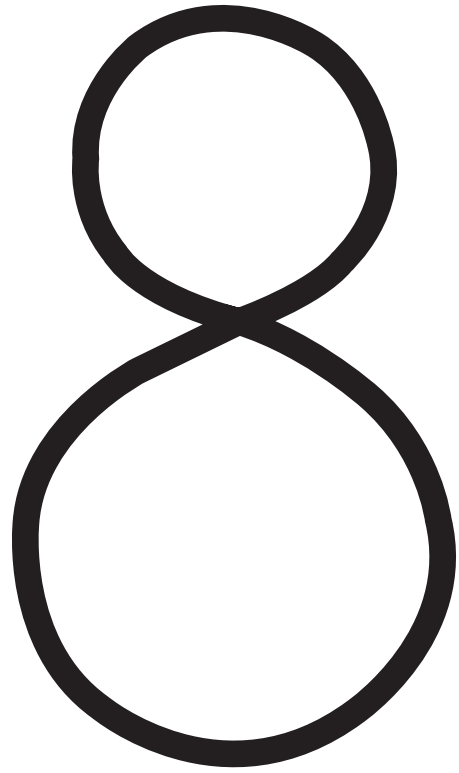
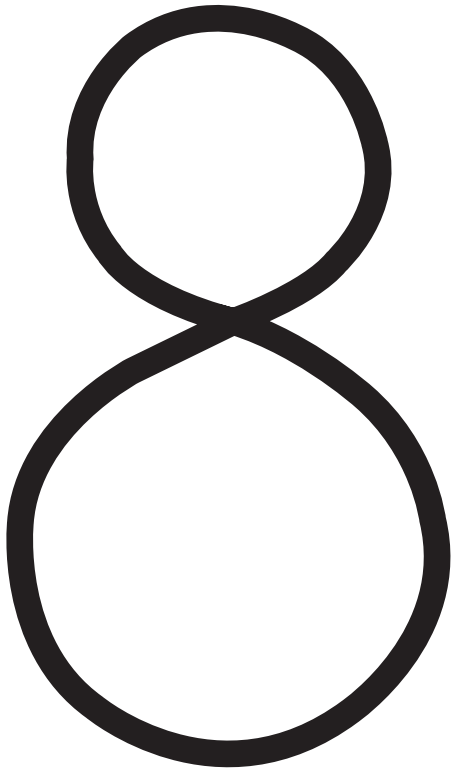

A NYOLCAS SZÁM VÁZOLÁSA

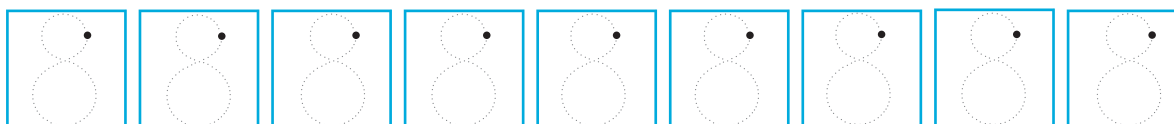
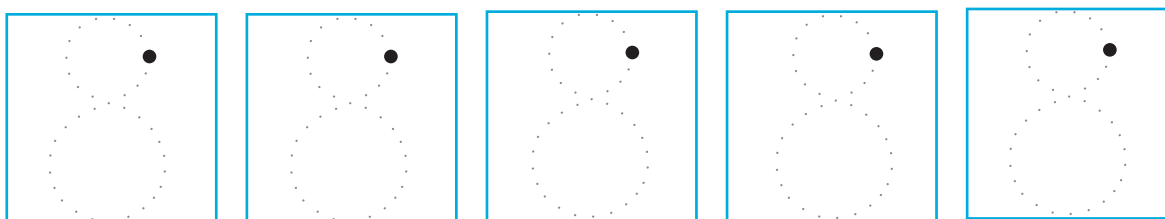
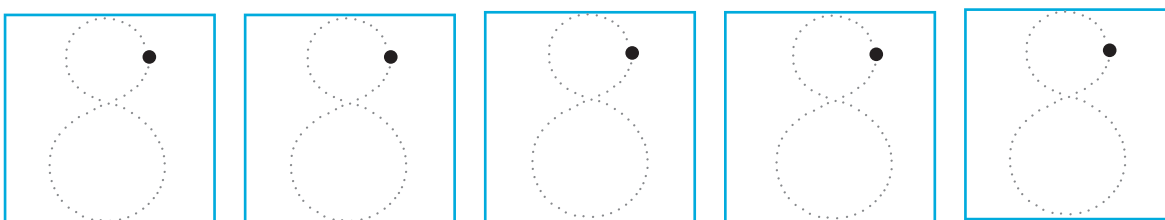
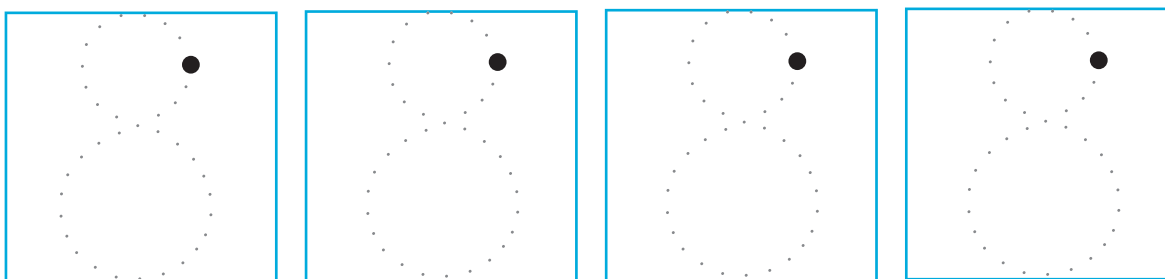
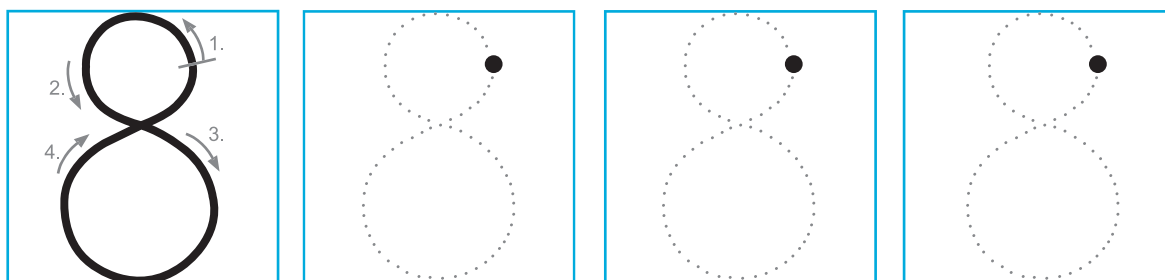

Keresd meg amiből 8 van és írd alá a számjelét!

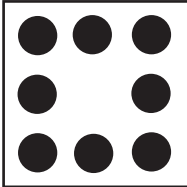
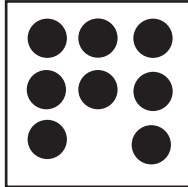
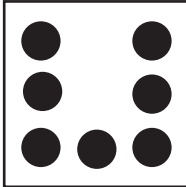
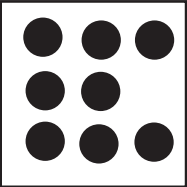
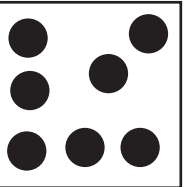
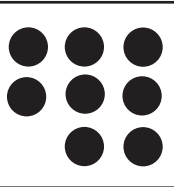
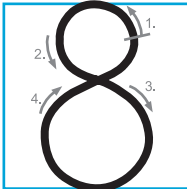

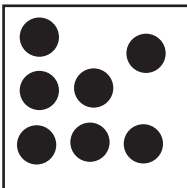
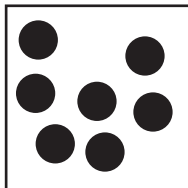
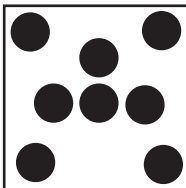
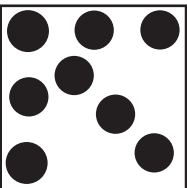
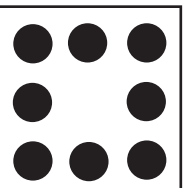
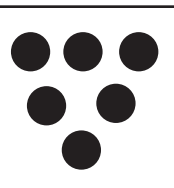

					

Rajzolj annyit, amennyit a szám mutat!

8	4	1	3	2	6

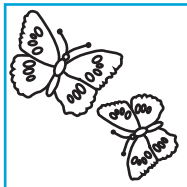
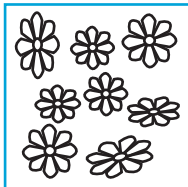
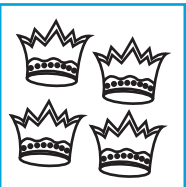
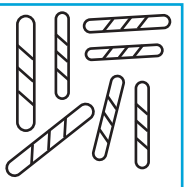
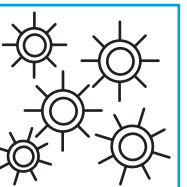
Írd az üres négyzetekbe, hogy mennyit látsz a képen!

					

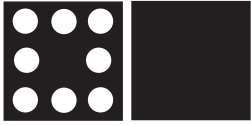

Folytasd! Indulj a kezdőponttól! Írd át többször a számokat!

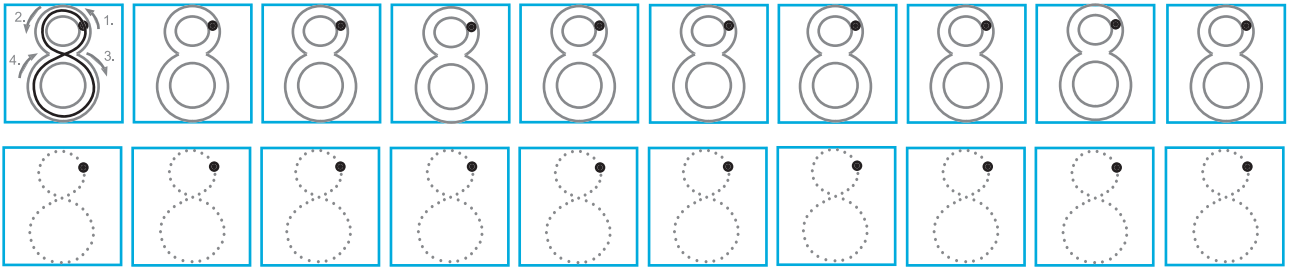

Figyelj a kezdőpontra!

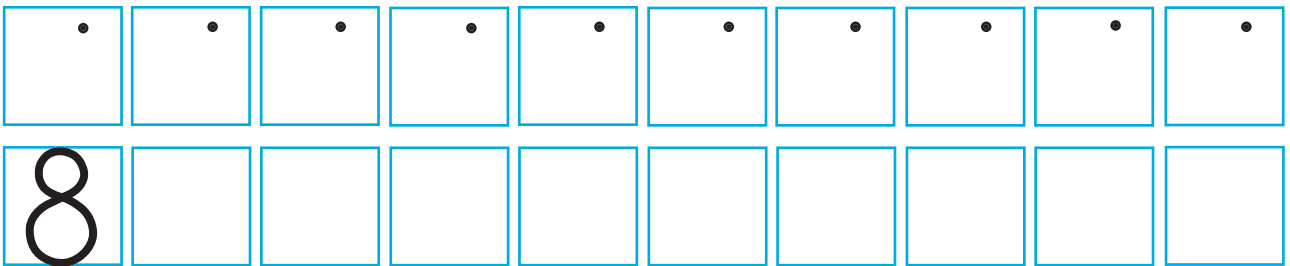

Folytasd!

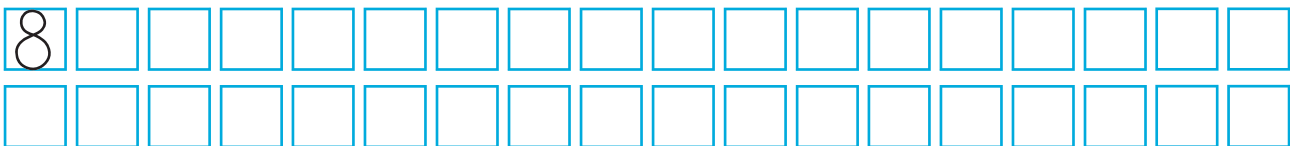

Írd át a helyes számjelet!

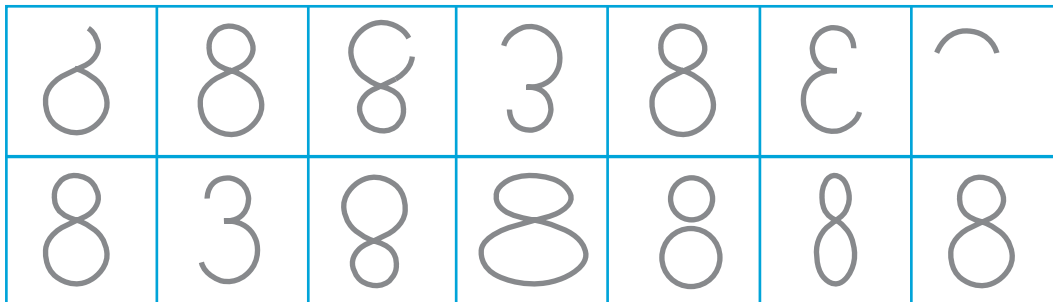

Karikázd be nyolcasával!

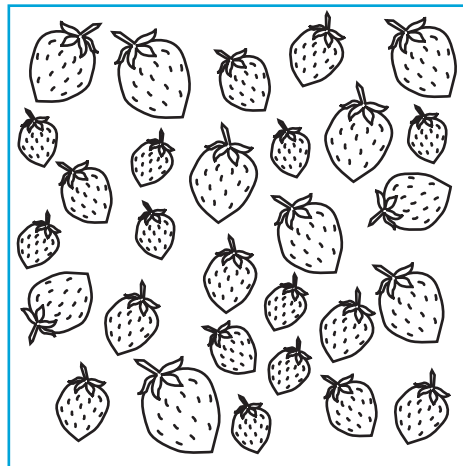
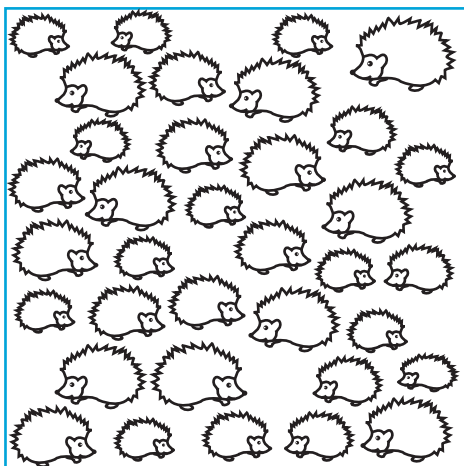

SZÁMSZIGET

Keress meg a kincshez (aranyóra) vezető utat!
Színezd ki azokat a kis
részeket, amelyekben pont nyolcat látsz!

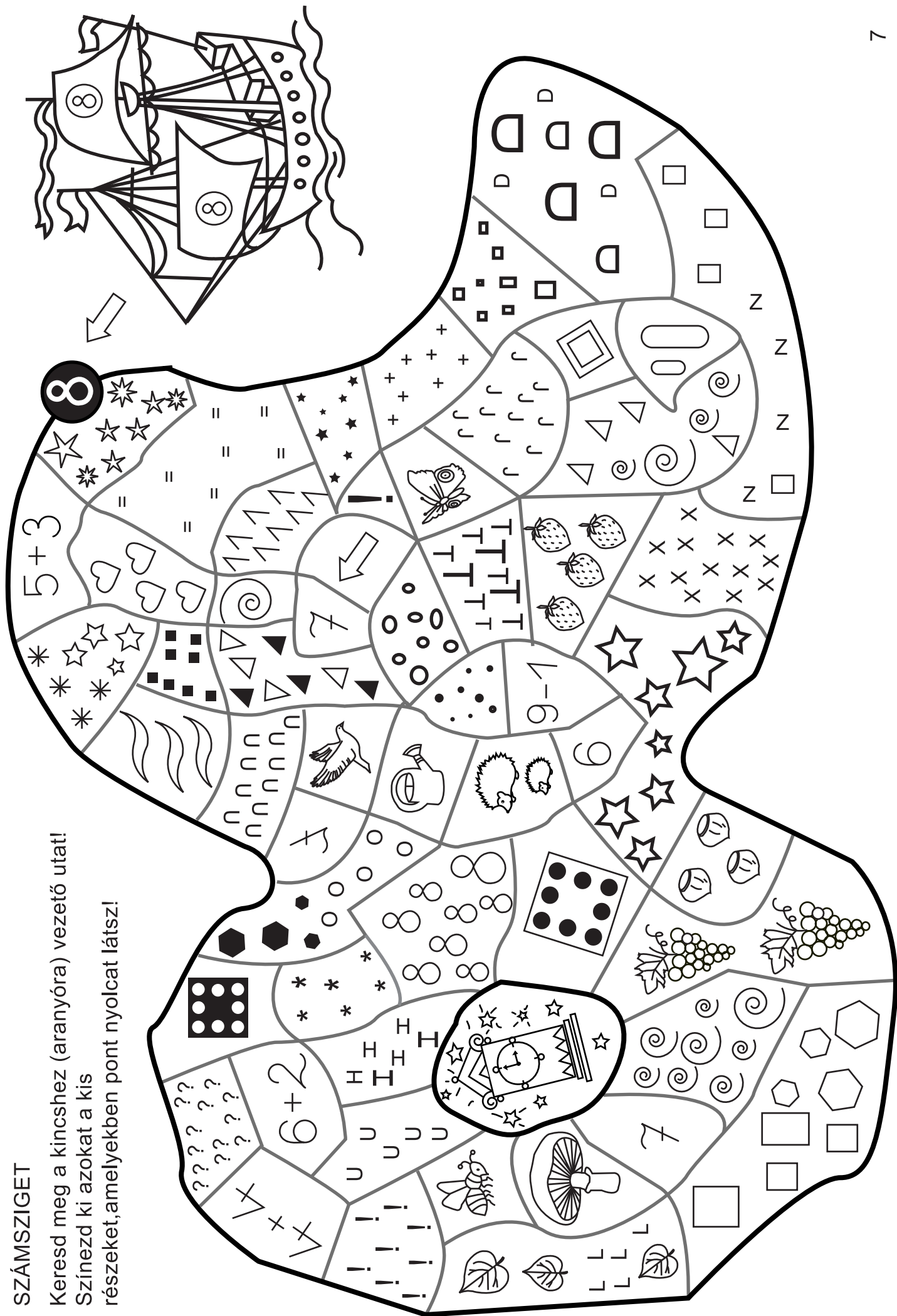

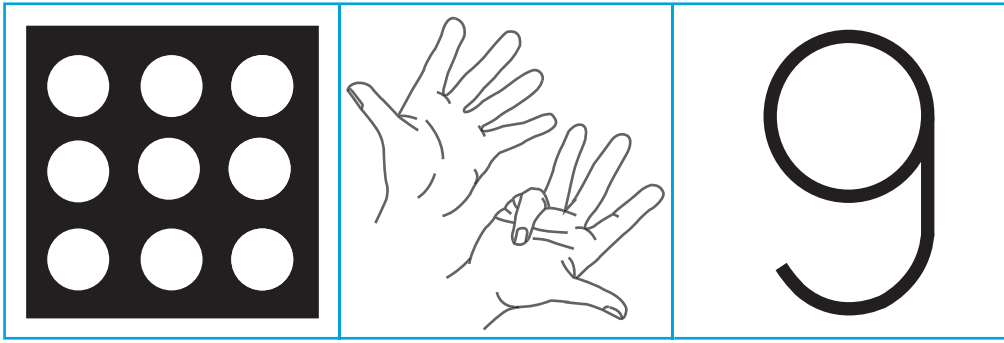

Színezd ki a rajzokat! Rajzolj valamiből kilencet az üres helyekre!

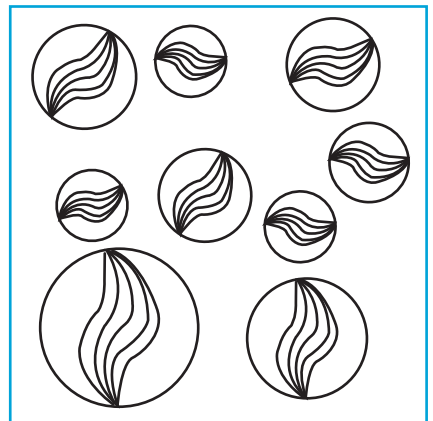
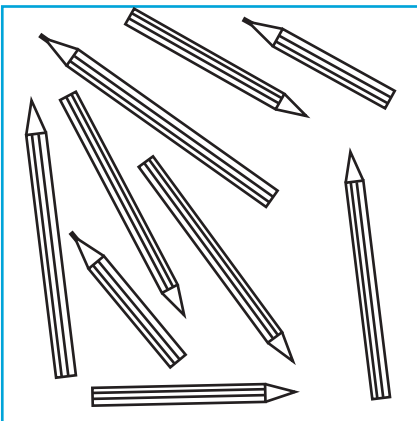
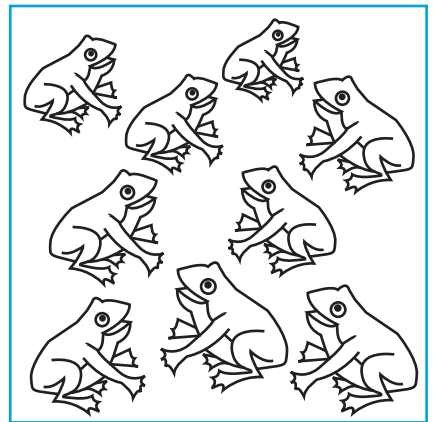
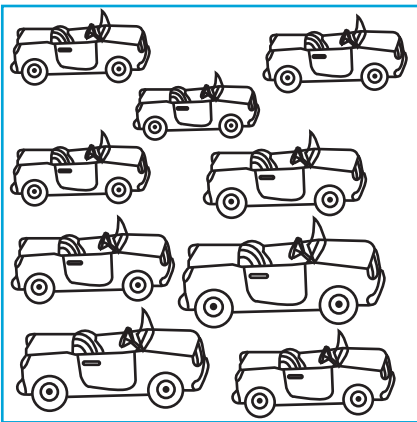
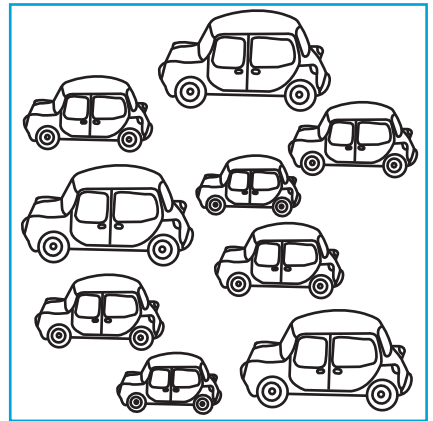
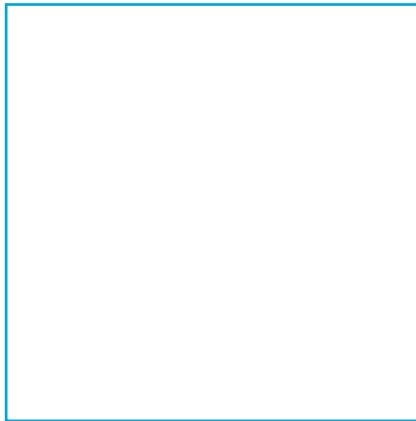

Vázold a kilences számot!
(Próbálj a vonalon belül maradni!)

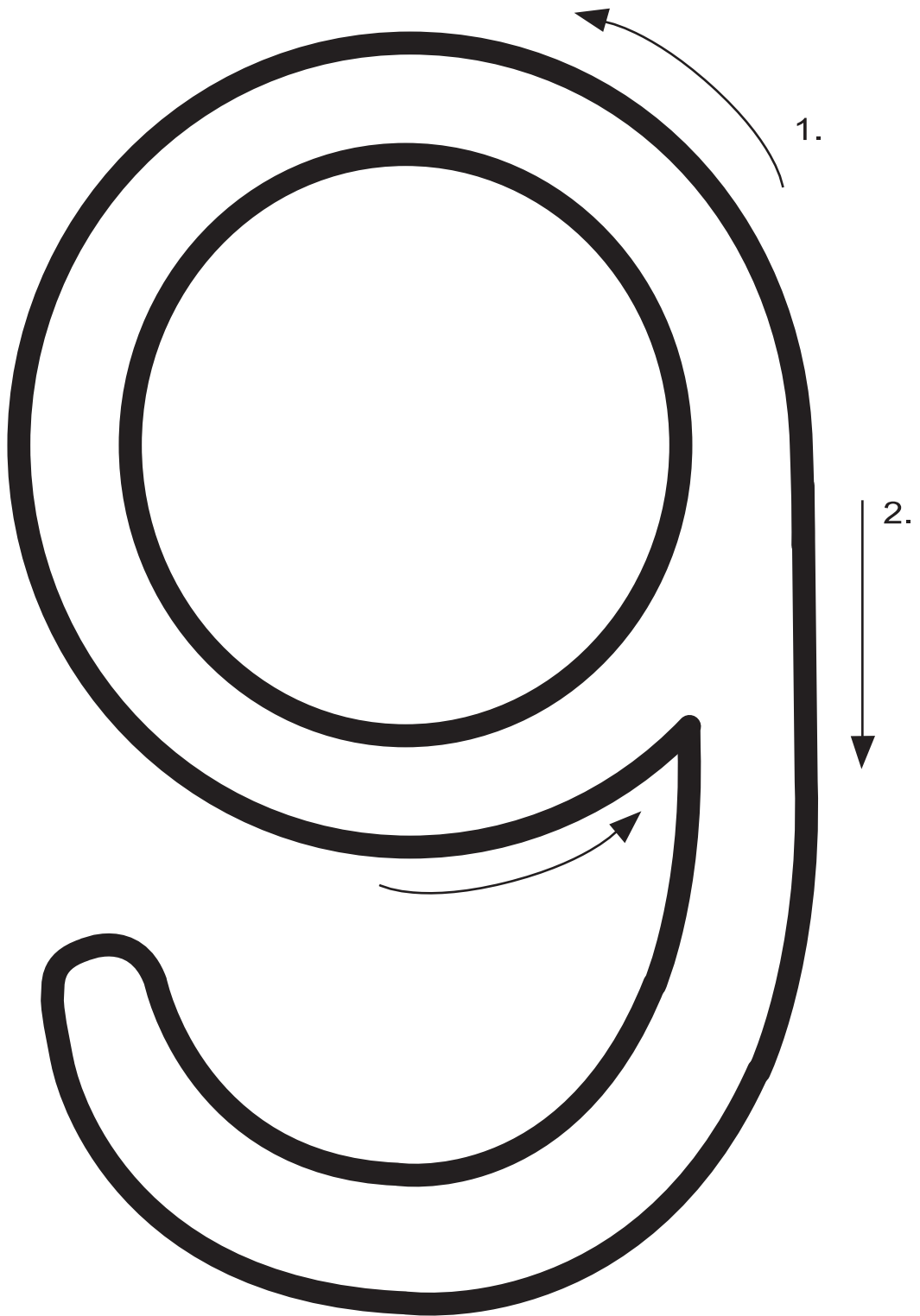

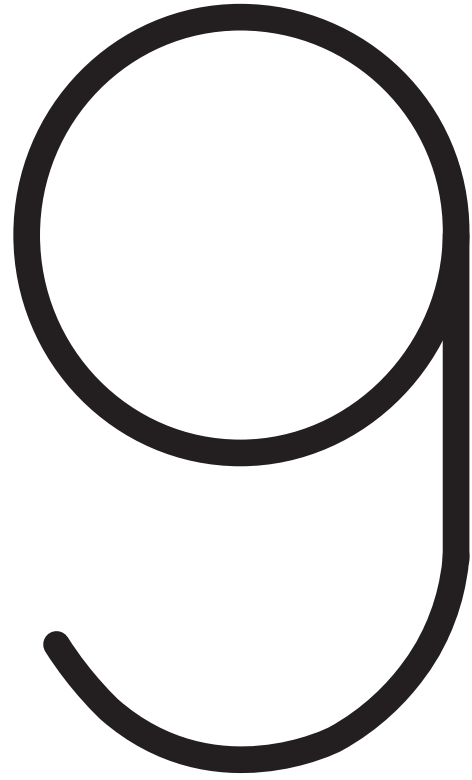
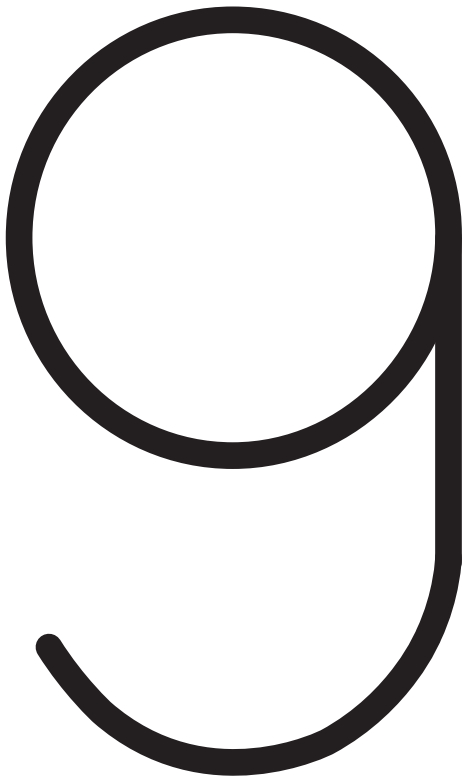
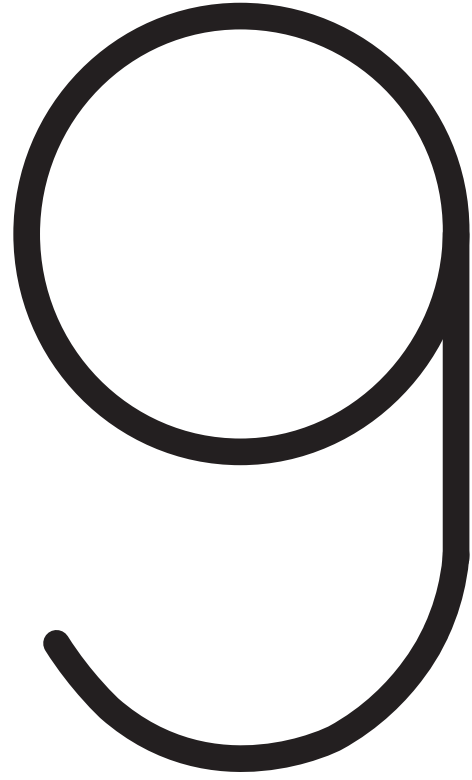
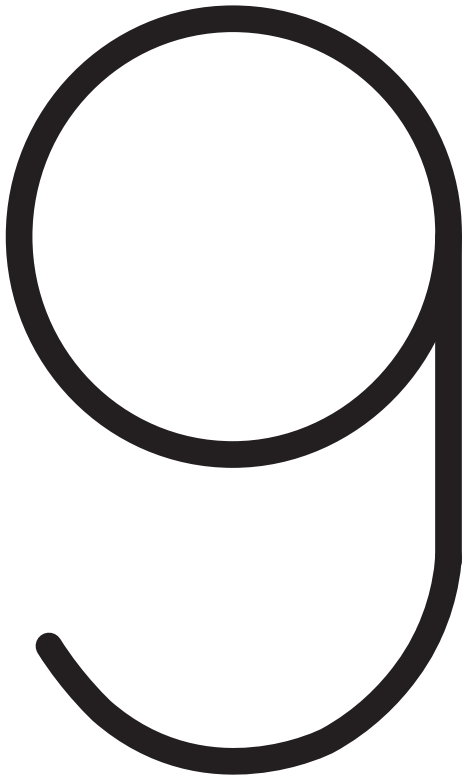

A KILENCES SZÁM VÁZOLÁSA

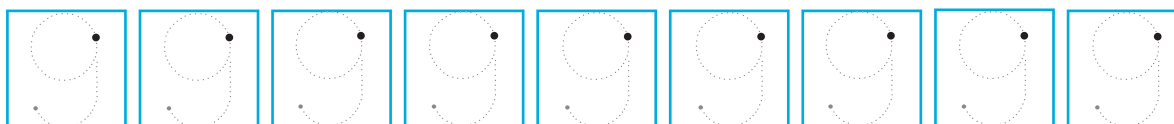
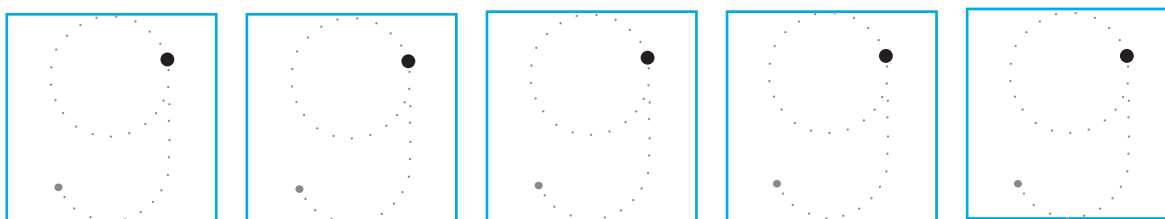
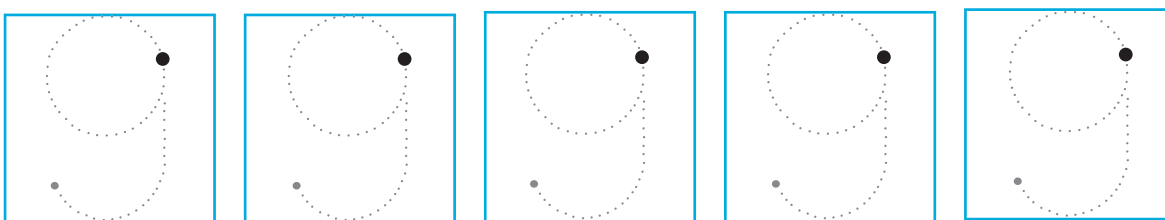
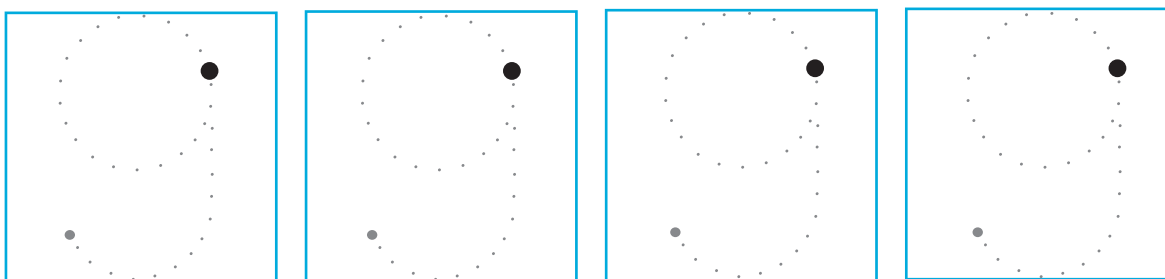
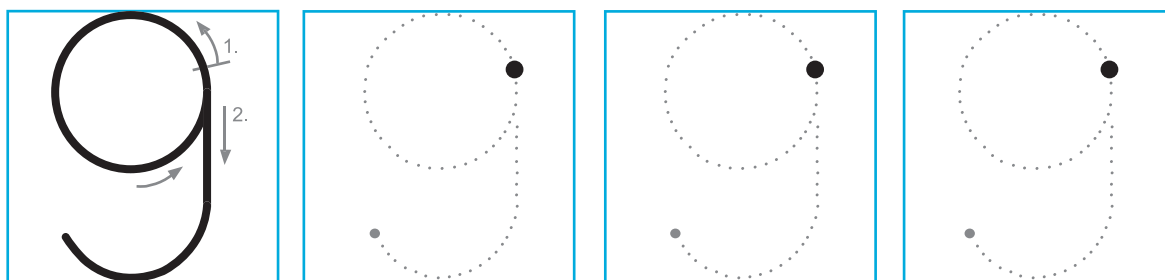

Keresd meg amiből 9 van és írd alá a számjelét!

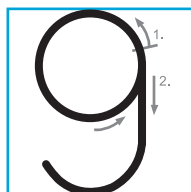
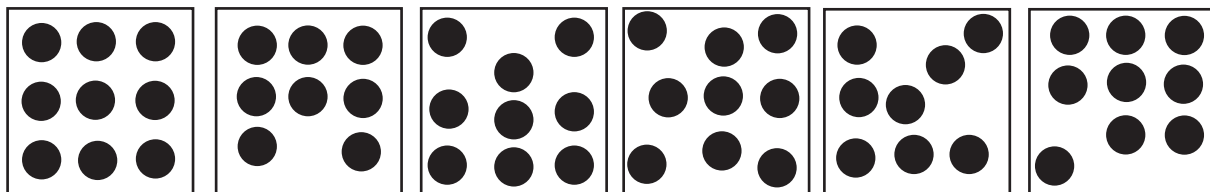

--	--	--	--	--	--

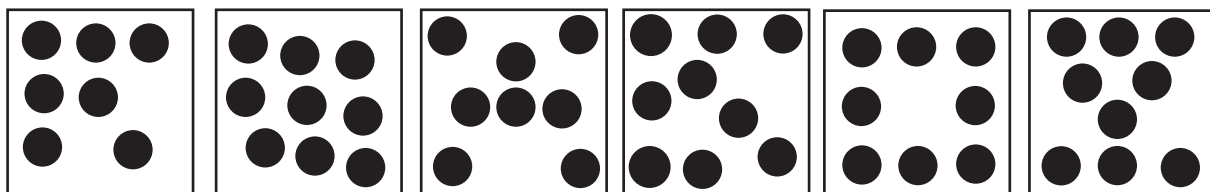

--	--	--	--	--	--

Rajzolj annyit, amennyit a szám mutat!

--	--	--	--	--	--



Írd az üres négyzetekbe, hogy mennyit látsz a képen!

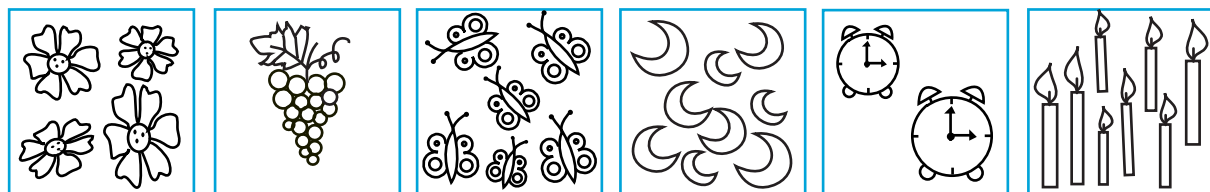

--	--	--	--	--	--



Folytasd! Indulj a kezdőponttól! Írd át többször a számokat!

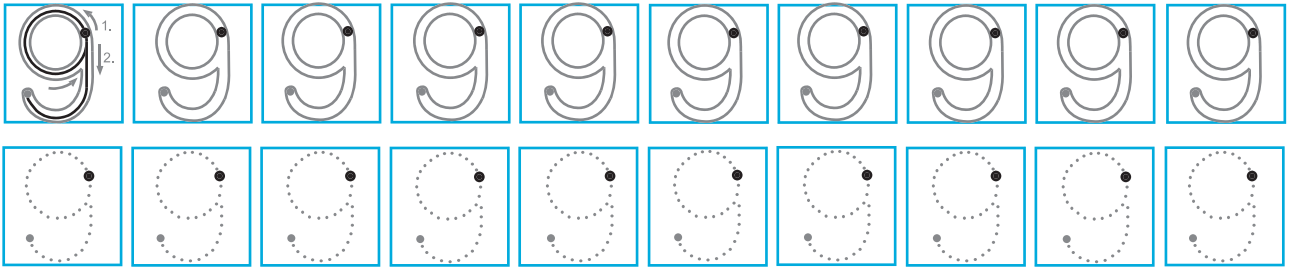

Figyelj a kezdőpontra!

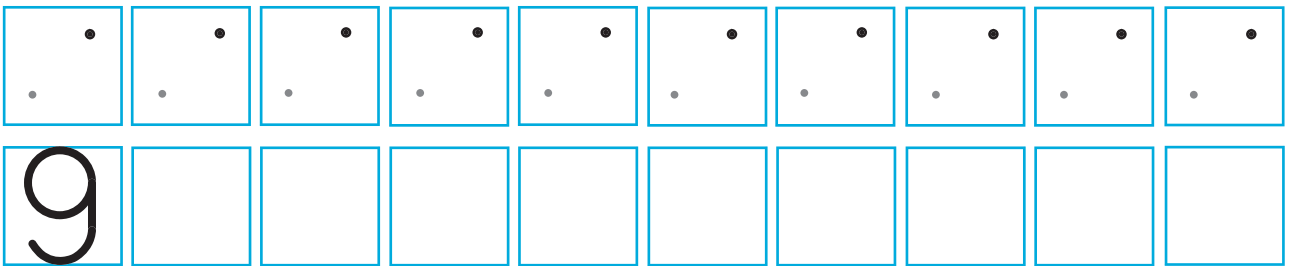

Folytasd!

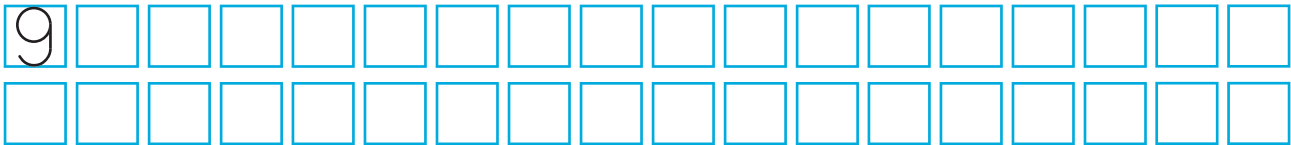

Írd át a helyes számjelet!

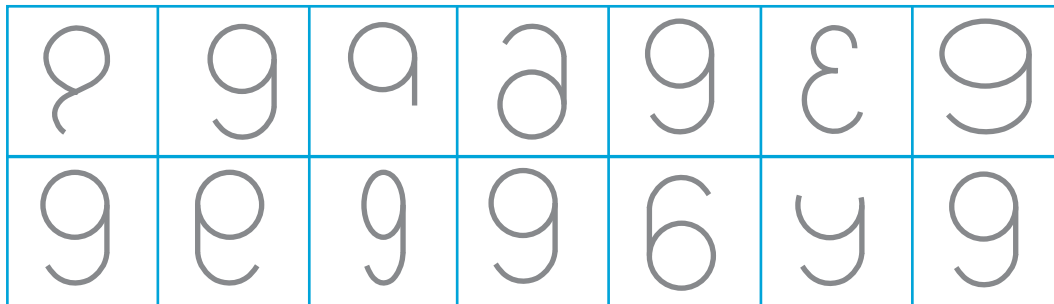

Karikázd be kilencesével!

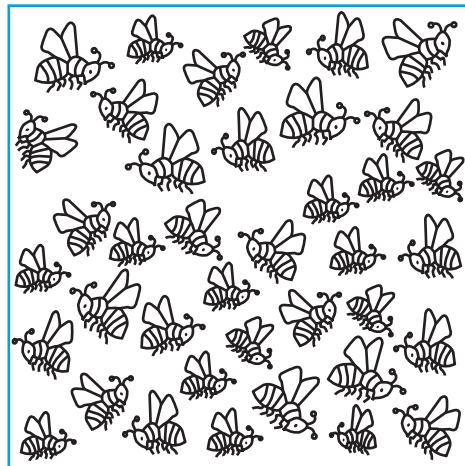
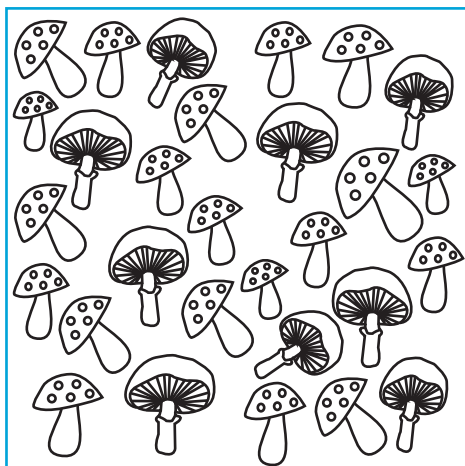

SZÁMSZIGET

Keress meg a kincshez (aranypénzek) vezető utat!
Színezd ki azokat a kis
részeket, amelyekben pont kilencet látsz!



Vázold a nullát!
(Próbáld a vonalon belül maradni!)

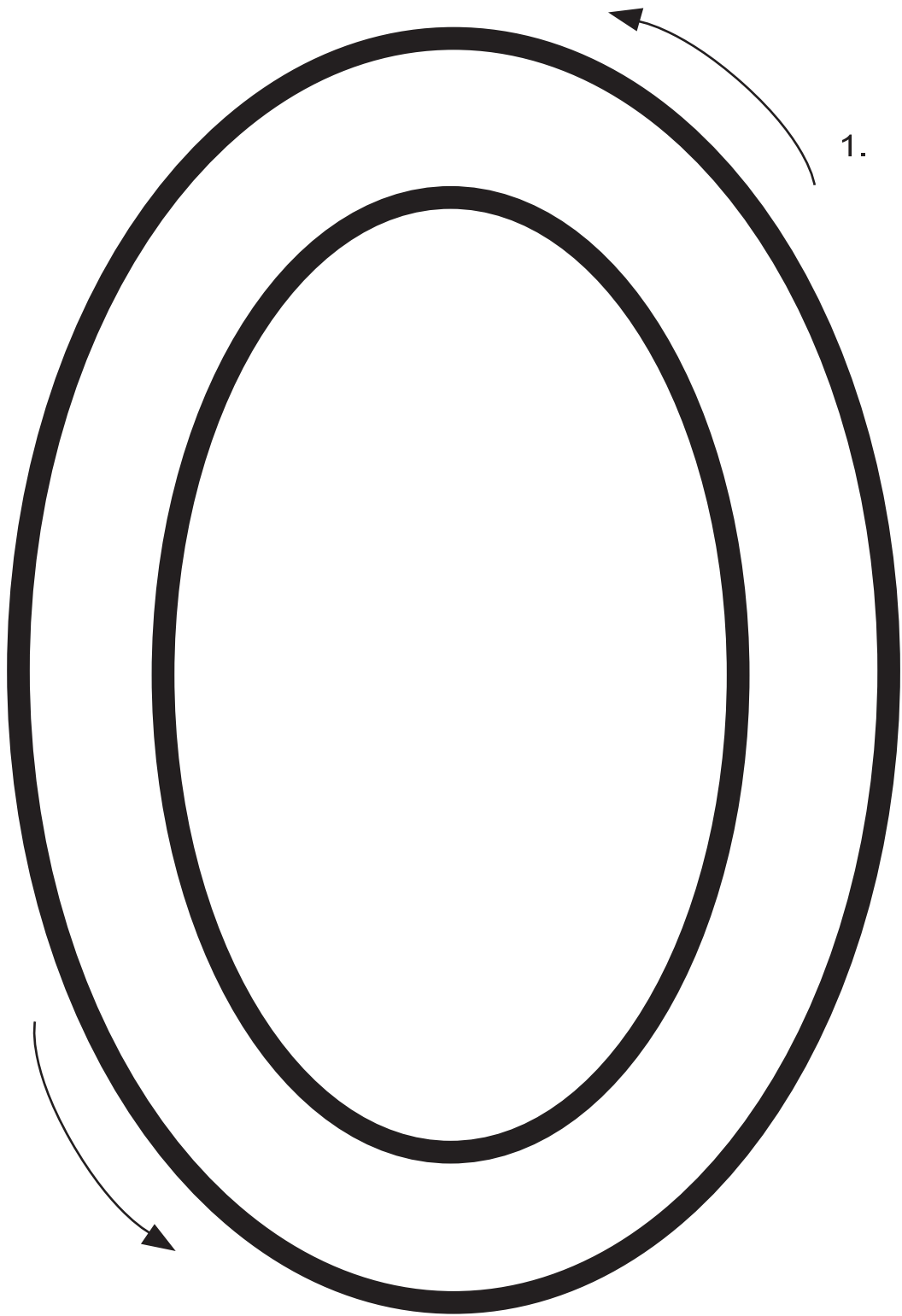

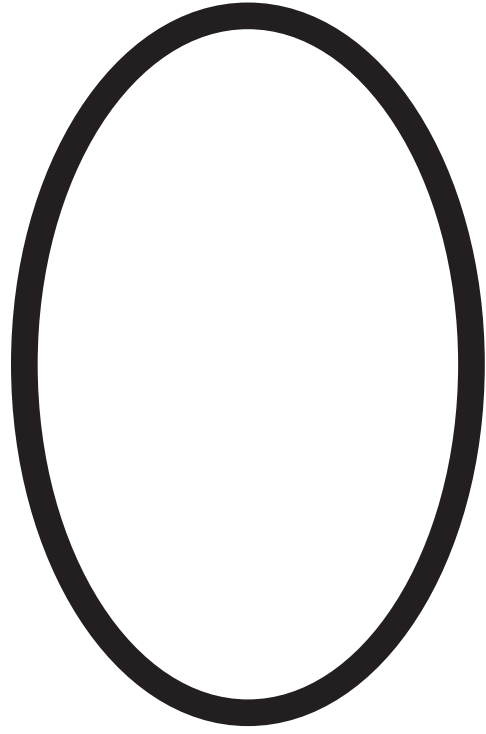
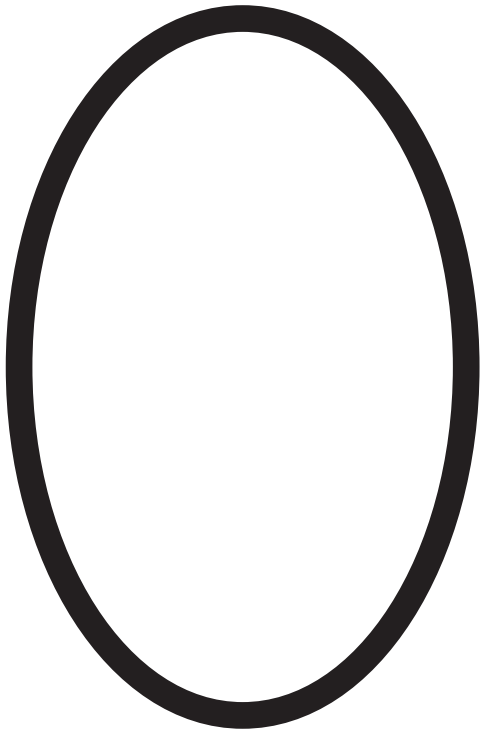
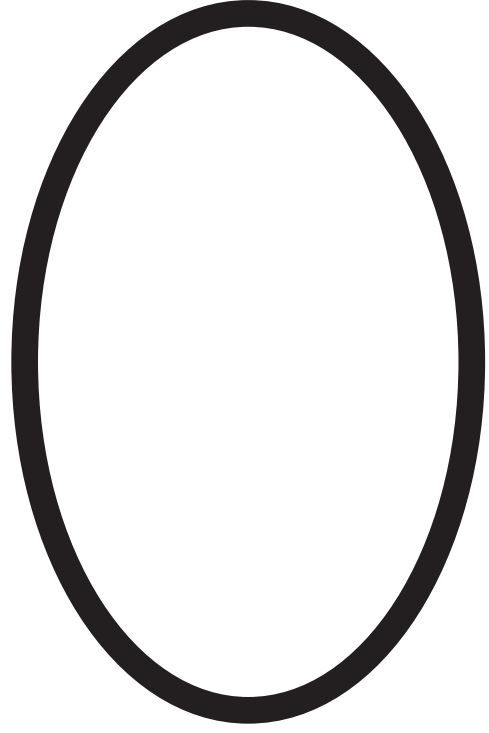
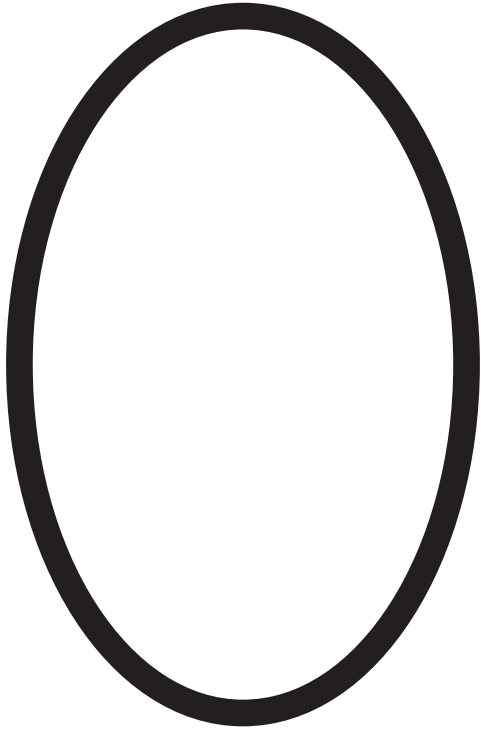

A NULLA VÁZOLÁSA

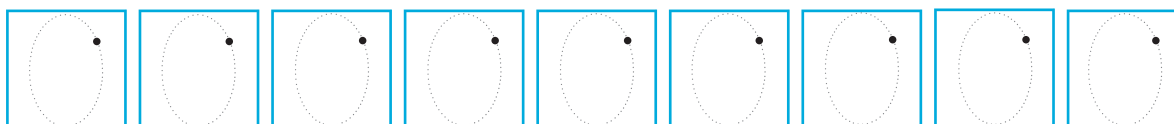
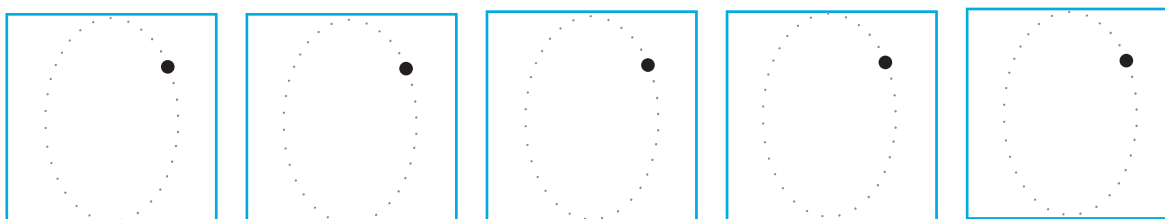
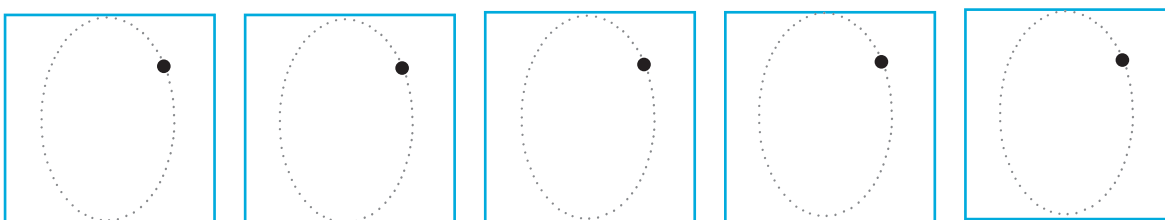
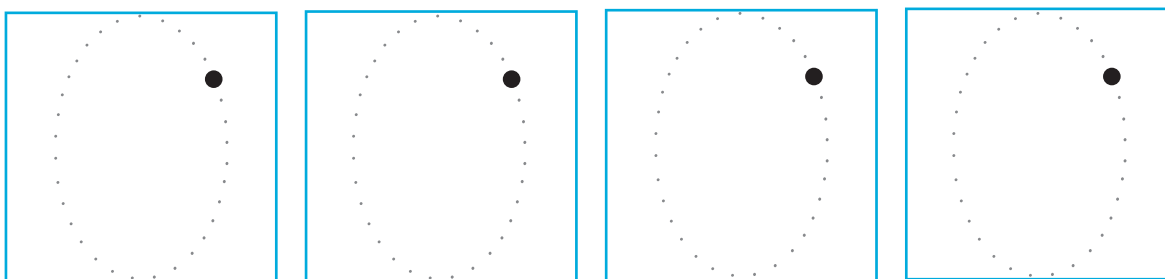
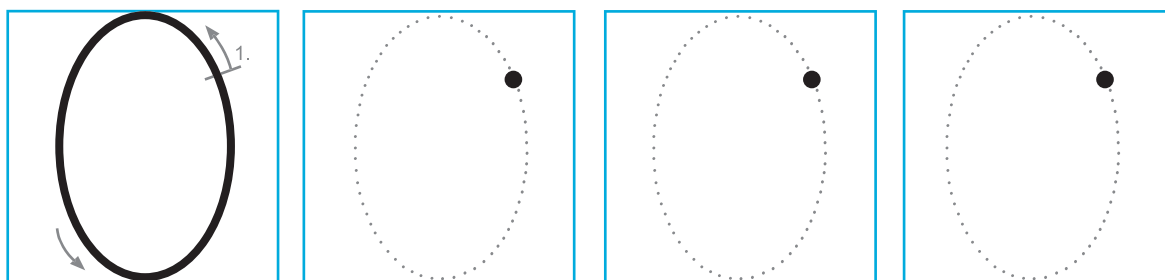



Folytasd! Indulj a kezdőponttól! Írd át többször a számokat!

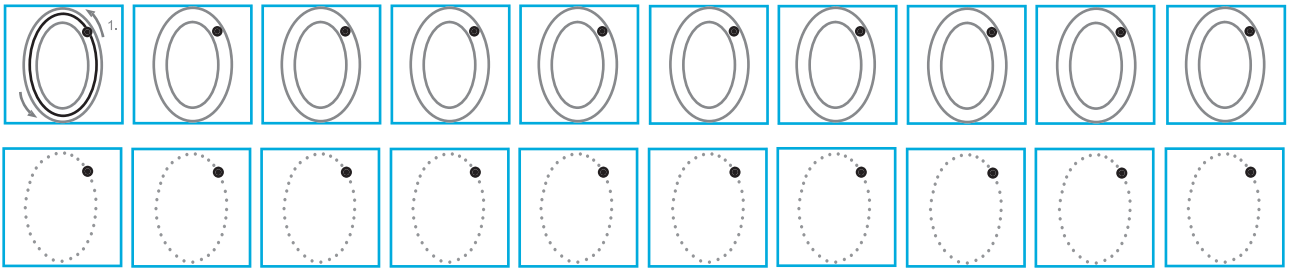

Figyelj a kezdőpontra!

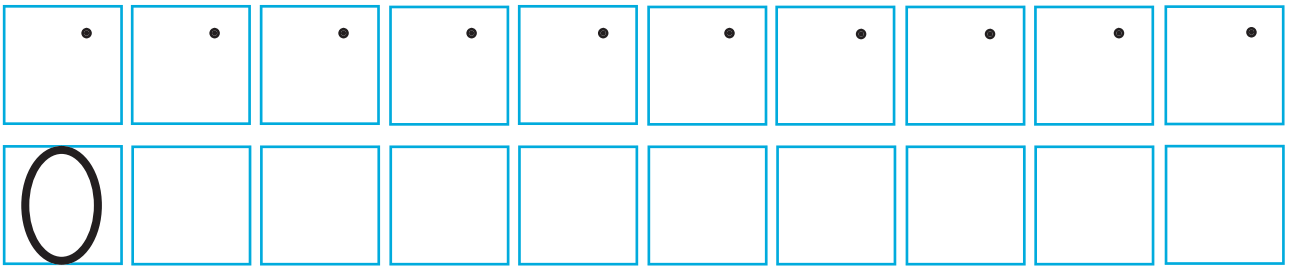

Folytasd!

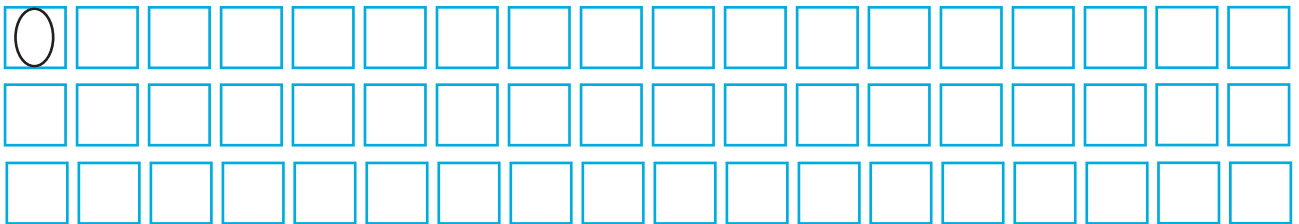

Írd át a helyes számjelet!

